

Gas Flow Multi-Meter

Models 5300 / 5310 / 5320 /
5330 / 5303



Operation and Service Manual

P/N 6011689, Revision G
June 2023



Start Seeing the Benefits of Registering Today!

Thank you for your TSI® instrument purchase. Occasionally, TSI® releases information on software updates, product enhancements and new products. By registering your instrument, TSI® will be able to send this important information to you.

<http://register.tsi.com>

As part of the registration process, you will be asked for your comments on TSI products and services. TSI's customer feedback program gives customers like you a way to tell us how we are doing.

Warranty

Copyright©

TSI Incorporated / 2019-2023 / All rights reserved.

Address

TSI Incorporated / 500 Cardigan Road / Shoreview, MN 55126 USA

	WARNING TSI® flow meters employ a heated platinum sensor. They should not be used with flammable or explosive gases or mixtures.
---	---

	CAUTION TSI® flow meters are not medical devices under FDA 510k and in no situation should they be utilized for human respiration measurements.
---	---

LIMITATION OF WARRANTY AND LIABILITY (effective February 2015)

(For country-specific terms and conditions outside of the USA, please visit www.tsi.com.)

Seller warrants the goods, excluding software, sold hereunder, under normal use and service as described in the operator's manual, to be free from defects in workmanship and material for **12 months**, or if less, the length of time specified in the operator's manual, from the date of shipment to the customer. This warranty period is inclusive of any statutory warranty. This limited warranty is subject to the following exclusions and exceptions:

- Hot-wire or hot-film sensors used with research anemometers, and certain other components when indicated in specifications, are warranted for 90 days from the date of shipment;
- Pumps are warranted for hours of operation as set forth in product or operator's manuals;
- Parts repaired or replaced as a result of repair services are warranted to be free from defects in workmanship and material, under normal use, for 90 days from the date of shipment;
- Seller does not provide any warranty on finished goods manufactured by others or on any fuses, batteries or other consumable materials. Only the original manufacturer's warranty applies;
- This warranty does not cover calibration requirements, and seller warrants only that the instrument or product is properly calibrated at the time of its manufacture. Instruments returned for calibration are not covered by this warranty;
- This warranty is **VOID** if the instrument is opened by anyone other than a factory authorized service center with the one exception where requirements set forth in the manual allow an operator to replace consumables or perform recommended cleaning;
- This warranty is **VOID** if the product has been misused, neglected, subjected to accidental or intentional damage, or is not properly installed, maintained, or cleaned according to the requirements of the manual. Unless specifically authorized in a separate writing by Seller, Seller makes no warranty with respect to, and shall have no liability in connection with, goods which are incorporated into other products or equipment, or which are modified by any person other than Seller.

The foregoing is **IN LIEU OF** all other warranties and is subject to the **LIMITATIONS** stated herein. **NO OTHER EXPRESS OR IMPLIED WARRANTY OF FITNESS FOR PARTICULAR PURPOSE OR MERCHANTABILITY IS MADE. WITH RESPECT TO SELLER'S BREACH OF THE IMPLIED WARRANTY AGAINST INFRINGEMENT, SAID WARRANTY IS LIMITED TO CLAIMS OF DIRECT INFRINGEMENT AND EXCLUDES CLAIMS OF CONTRIBUTORY OR INDUCED INFRINGEMENTS. BUYER'S EXCLUSIVE REMEDY SHALL BE THE RETURN OF THE PURCHASE PRICE DISCOUNTED FOR REASONABLE WEAR AND TEAR OR AT SELLER'S OPTION REPLACEMENT OF THE GOODS WITH NON-INFRINGEMENT GOODS.**

TO THE EXTENT PERMITTED BY LAW, THE EXCLUSIVE REMEDY OF THE USER OR BUYER, AND THE LIMIT OF SELLER'S LIABILITY FOR ANY AND ALL LOSSES, INJURIES, OR DAMAGES CONCERNING THE GOODS (INCLUDING CLAIMS BASED ON CONTRACT, NEGLIGENCE, TORT, STRICT LIABILITY OR OTHERWISE) SHALL BE THE RETURN OF GOODS TO SELLER AND THE REFUND OF THE PURCHASE PRICE, OR, AT THE OPTION OF SELLER, THE REPAIR OR REPLACEMENT OF THE GOODS. IN THE CASE OF SOFTWARE, SELLER WILL REPAIR OR REPLACE DEFECTIVE SOFTWARE OR IF UNABLE TO DO SO, WILL REFUND THE PURCHASE PRICE OF THE SOFTWARE. IN NO EVENT SHALL SELLER BE LIABLE FOR LOST PROFITS, BUSINESS INTERRUPTION, OR ANY SPECIAL, INDIRECT, CONSEQUENTIAL OR INCIDENTAL DAMAGES. SELLER SHALL NOT BE RESPONSIBLE FOR INSTALLATION, DISMANTLING OR REINSTALLATION COSTS OR CHARGES. No Action, regardless of form, may be brought against Seller more than 12 months after a cause of action has accrued. The goods returned under warranty to Seller's factory shall be at Buyer's risk of loss, and will be returned, if at all, at Seller's risk of loss.

Buyer and all users are deemed to have accepted this LIMITATION OF WARRANTY AND LIABILITY, which contains the complete and exclusive limited warranty of Seller. This LIMITATION OF WARRANTY AND LIABILITY may not be amended, modified or its terms waived, except by writing signed by an Officer of Seller.

Service Policy

Knowing that inoperative or defective instruments are as detrimental to TSI attention to any problems. If any malfunction is discovered, please contact your nearest sales office or representative, or call TSI's Customer Service department at (800) 680-1220 (USA) or (001 651) 490-2860 (International) or visit www.tsi.com.

Trademarks

TSI and the TSI logo are registered trademarks of TSI Incorporated in the United States and may be protected under other country's trademark registrations.

Contents

Warranty.....	iii
Contents.....	v
CHAPTER 1 Unpacking and Parts Identification.....	1
List of Standard Components.....	1
5300 Series High Flow Gas Flow Multi-Meter	1
Standard Accessory Kit.....	2
5300 Series Standard Accessory Kit (53000).....	2
Low Pressure Measurement Kit.....	3
5300 Series Low Pressure Measurement Kit (5300-LPMK).....	3
Optional Accessories.....	3
5300 Series Accessories	3
5000 Series Universal Accessories	4
CHAPTER 2 Meter Setup	7
Instrument Overview	7
5300 Series High Flow Gas Flow Multi-Meter	7
Supplying Power	8
USB Hub Cable.....	8
Communications.....	9
USB-C to USB-A Cable	9
USB-A to RS-232 Cable	10
Connecting Inlet Filter	11
Changing Tube Ends.....	12
Using 0.5 inch or 15 mm Tube Ends.....	13
Low Pressure Measurement Kit	14
5300 Series Low Pressure Measurement Kit (5300-LPMK).....	14
CHAPTER 3 Meter Operation	17
Getting Started	17
Power Button	17
Initialization and Warm-Up.....	17
Touchscreen Display	17
Measurement Parameters.....	17
Flow Measurement	17
Temperature Measurement	18
Absolute Pressure Measurement	18
Low Differential Pressure Measurement.....	18
Relative Humidity Measurement.....	18
Volume Measurement.....	18
Totalizer Measurement	18
Units of Measurement	19
Type of Gas.....	19
Model Numbers based on Gas Calibration.....	19
Meter Configuration.....	20
Data Logging	20
Preset Logging Configurations and Sample Points	20
CHAPTER 4 Touchscreen Navigation	21
Display Overview.....	21
Meter Home Screen.....	21
Menu Screen.....	22
Measurements	22

Type of Gas.....	22
Flow Directional Indicators.....	23
Pause/Play Display.....	23
Configuring the Meter.....	24
Measurement Parameters.....	24
Units of Measurement.....	24
Flow Conditions.....	25
Type of Gas.....	25
Locking the Meter.....	26
Volume and Triggers.....	27
Setting Triggers.....	28
Making Volume Measurements.....	29
Data Logging.....	30
Logging Parameters.....	30
Log Data.....	31
Export Data Files.....	31
Delete Data Files.....	32
Rotate Screen.....	33
Alerts.....	33
Meter Information.....	34
Updating Firmware.....	35
Device Settings.....	36
Reset Device Settings.....	38
Zero Low Pressure.....	39
Reset Totalizer.....	39
Reset Device to Factory Defaults.....	39
CHAPTER 5 Maintenance.....	41
Flow Sensor.....	41
Re-Certification.....	41
Damaged Tube End Connections.....	41
Cases.....	41
Storage.....	42
CHAPTER 6 Troubleshooting.....	43
Technical Contacts.....	44
Returning the Gas Flow Multi-Meter for Service.....	44
CHAPTER 7 FLO-Sight™ PC Software.....	45
CHAPTER 8 Serial Command Set.....	47
Commands for Flow Rate, Temperature, Pressure, and Volume.....	47
Measurement Setup Commands.....	47
Miscellaneous Commands.....	48
APPENDIX A 5300 Series Flow Multi-Meter Specifications.....	49
5300 Series Pressure Drop.....	51
5300 Series Dimensions.....	52
APPENDIX B Standard Flow Rate vs. Volumetric Flow Rate.....	53
APPENDIX C Humidity Compensation.....	55
Disable / Enable Humidity Compensation.....	55
APPENDIX D Remote Flow.....	57
Theory of Operation.....	57
Remote Flow Setup.....	57

CHAPTER 1

Unpacking and Parts Identification

List of Standard Components

Carefully unpack the instrument and accessories from the shipping container. Check the individual parts against the list of components in tables below. If any parts are missing or damaged, notify TSI® immediately.

5300 Series High Flow Gas Flow Multi-Meter

Qty.	Item Description	Part/Model
1	High Flow Gas Flow Multi-Meter, 22-mm ISO tube ends Measures Flow, Temperature, Absolute Pressure	5300
	High Flow Gas Flow Multi-Meter, 22-mm ISO tube ends Measures Flow, Volume, Temperature, Absolute Pressure, Differential Pressure	5310
	High Flow Gas Flow Multi-Meter, 22-mm ISO tube ends Measures Flow, Volume, Temperature, Absolute Pressure, Differential Pressure, Relative Humidity	5320
	High Flow Gas Flow Multi-Meter (High Accuracy), 22-mm ISO tube ends, includes Tabletop Stand Measures Flow, Volume, Temperature, Absolute Pressure, Differential Pressure, Relative Humidity	5330
	High Flow Gas Flow Multi-Meter (Wide Accuracy Spec), 22-mm ISO tube ends Measures Flow, Temperature, Absolute Pressure	5303
1	Calibration Certificate	N/A
1	5300 Series Standard Accessory Kit	53000
1	Low Pressure Measurement Kit (5310/5320/5330 models only)	5300-LPMK
1	License key for FLO-Sight™ PC Software (Includes a free trial of the advanced version)	5000-PC

*FLO-Sight PC Software can be downloaded from www.tsi.com.



Standard Accessory Kit

5300 Series Standard Accessory Kit (53000)

Item Description	TSI® Part Number	Picture
5300 Series 1/2 inch Tube Ends (2)	5300-05IN	
5300 Series Inlet Filter Low Pressure	5300-IF-LP	
5000 Series USB-C to USB-A Power and Communications Cable (6 ft.)	5000-USBC-A	
5000 Series Universal Power Supply 5.0 VDC ±5%, 500 mA maximum	5000-UPS	
5000 Series USB Hub Cable	5000-HUB	



Low Pressure Measurement Kit



5300 Series Low Pressure Measurement Kit (5300-LPMK)

Item Description	Quantity	Picture
22 mm (M/F) Airway Pressure Fitting with Screen	2	
1/8 inch ID x 1/4 inch OD Tubing	96 inches	

Optional Accessories



5300 Series Accessories

Item Description	TSI® Part Number	Picture
5300 Series 22 mm M/15 mm F ISO Tube Ends (2)	5300-22MM	
5300 Series 1/2 inch Tube Ends (2)	5300-05IN	
5300 Series 15 mm ISO Tube Ends (2)	5300-15MM	
5300 Series 3/4 inch Tube Ends (2)	5300-075IN	
5300 Series High Pressure 3/8 inch NPT Tube Ends (2)	5300-375NPT	
5300 Series End Caps (2)	5300-EC	

Item Description	TSI® Part Number	Picture
5300 Series Collars (2)	5300-C	
5300 Series High Pressure Kit	5300-HPK	
5300 Series Inlet Filter – High Pressure	5300-IF-HP	

5000 Series Universal Accessories

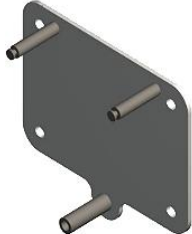
Item Description	TSI® Part Number	Picture
5000 Series Tabletop Stand	5000-TTS	
5000 Series USB-C to USB-A Power and Communications Cable with Screw Lock (6 ft.)	5000-USB-LOCK	
5000 Series USB-RS-232 Cable with Null Modem Converter	5000-RS232	
5000 Series Wall Mounting Kit	5000-WMK	
5000 Series Wall Mounting – DIN Rail Kit	5000-WMDRK	

Item Description	TSI® Part Number	Picture
5000 Series Wall Mounting – Back Plate Only	5000-WMBP	
5000 Series Wall Mounting – Meter Plate Only	5000-WMMP	
5000 Series Wall Mounting DIN Rail – Clips Only (2)	5000-WMDRC	
5000 Series Deluxe Carrying Case	5000-DCC	
FLO-Sight™ PC Software (Advanced Version)	5000-PC-ADV	See Chapter 7 for more information.

(This page intentionally left blank)

CHAPTER 2

Meter Setup

Instrument Overview

5300 Series High Flow Gas Flow Multi-Meter

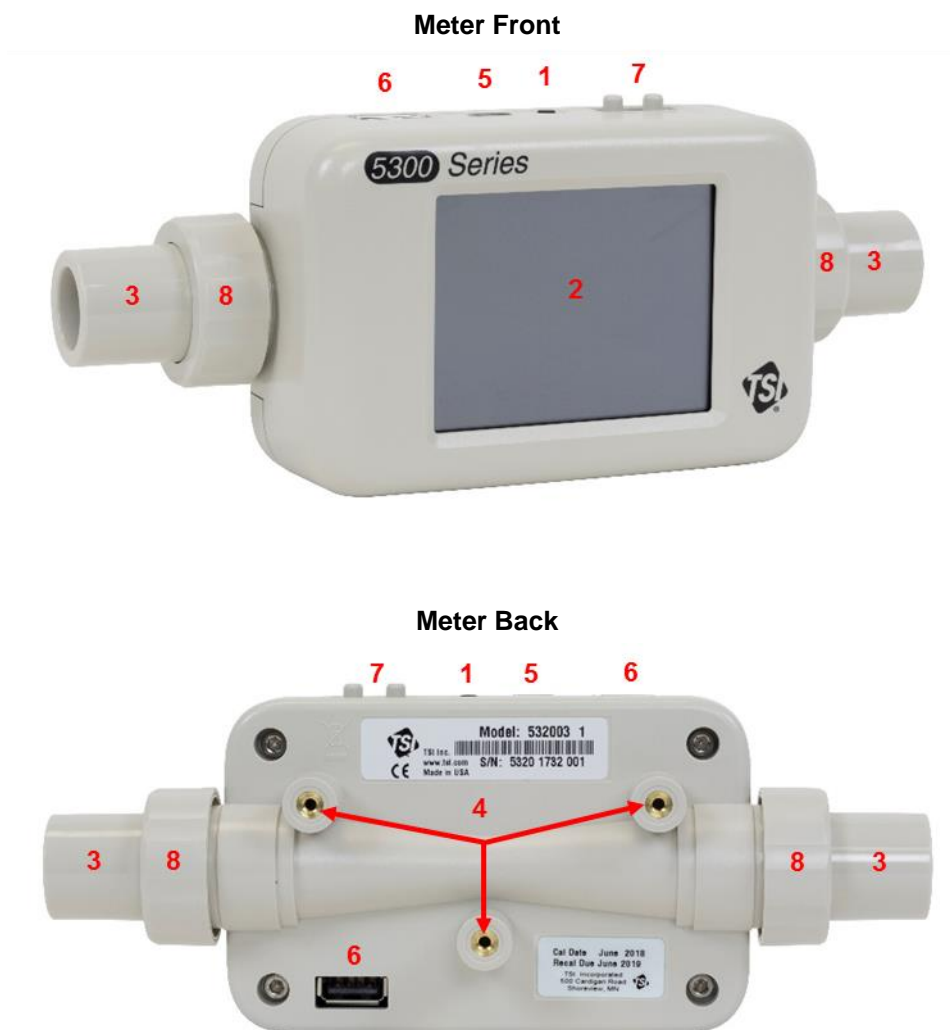

1. Power Button (On/Off)	5. USB-C Power / Communications Port
2. Color Touchscreen Display *	6. USB-A Communications Ports (2)
3. Interchangeable Tube Ends	7. Differential Pressure Ports (5310 / 5320 / 5330 models only)
4. Mounting Inserts (M3 thread size)	8. Collars

* The touchscreen display is resistive and responds to applied pressure

Supplying Power

The 5300 Series Multi-Meter can be powered by connecting the USB-C to USB-A Power and Communications Cable from the USB-C port on the meter to: 1) the 5000 Series Universal Power Supply, 2) a computer, or 3) an alternative USB-compatible source that can provide 5 VDC.



Power Supply: 5.0 VDC \pm 5%, 500 mA maximum

USB Hub Cable

Some computer USB ports are not capable of sufficiently powering the meter. The meter may fail to power on, or the meter may power on but be unable to complete the startup process.

If you are unable to power your meter from the computer, connect using the provided USB hub cable. To do this, connect the USBC-A power cable to the USB hub cable, plug the hub cable into the USB-A port of the computer, and plug the other end of the USBC-A cable into the USB-C port located on top of the meter.

Communications

USB-C to USB-A Cable

In addition to supplying power, the 5000 Series USB-C to USB-A cable (5000-USBC-A) provides direct communication between the Multi-Meter and a computer. The graphic to the right shows the connection scheme.

You can view real-time measurements and control your meter through FLO-Sight™ PC Software or through an alternative program such as HyperTerminal® or PuTTY using ASCII commands.

For more details, please refer to the *FLO-Sight™ PC Software Manual* or the *Series 5200/5300 ASCII Command Set Manual*.

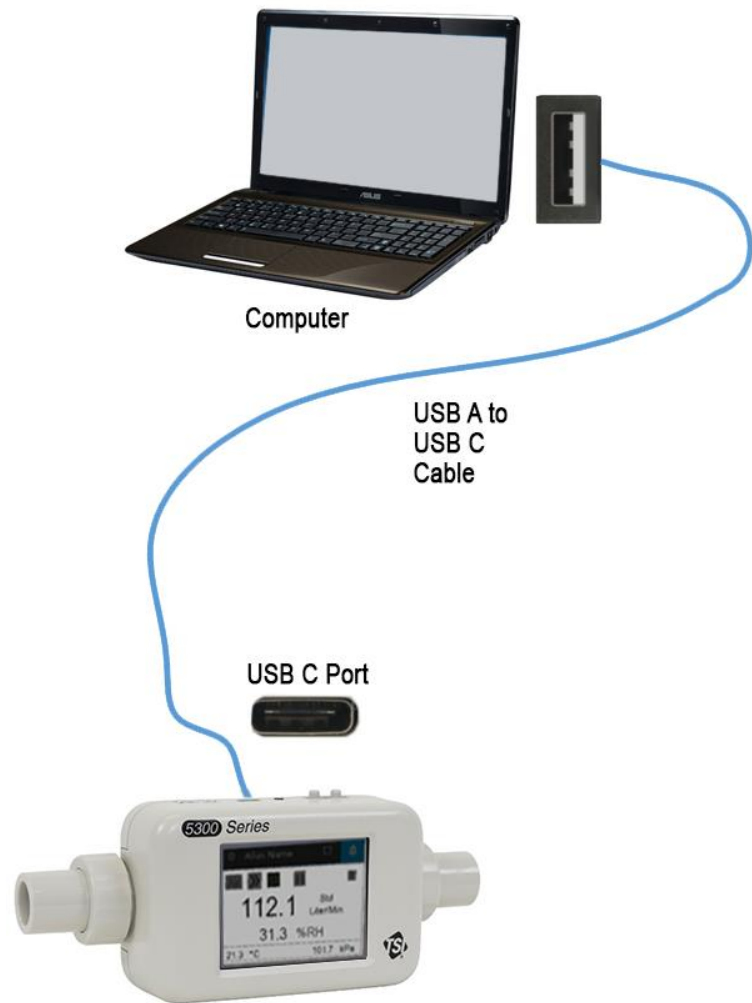

®HyperTerminal is a registered trademark of Hilgraeve, Incorporated

USB-A to RS-232 Cable

To communicate via serial, you can purchase the optional USB-A to RS-232 Serial Cable Kit (5000-RS232) which is comprised of a USB-A to RS-232 serial cable and null modem converter. The cable can be connected from either USB-A port on the meter. See the image below for connecting the Multi-Meter via RS-232.

NOTICE

The Multi-Meter must be rebooted after connecting the adapter and cable in order to load the driver.

Once the cable is connected and the meter has been rebooted, you can communicate via serial with the ASCII commands found in the *Series 5200/5300 ASCII Command Set Manual*.

RS-232 Settings

- Baud Rate 115,200 k (by default, unit can be switched to 38.4 k)
- Data Bits 8
- Parity None
- Stop Bits 1
- Flow Control None

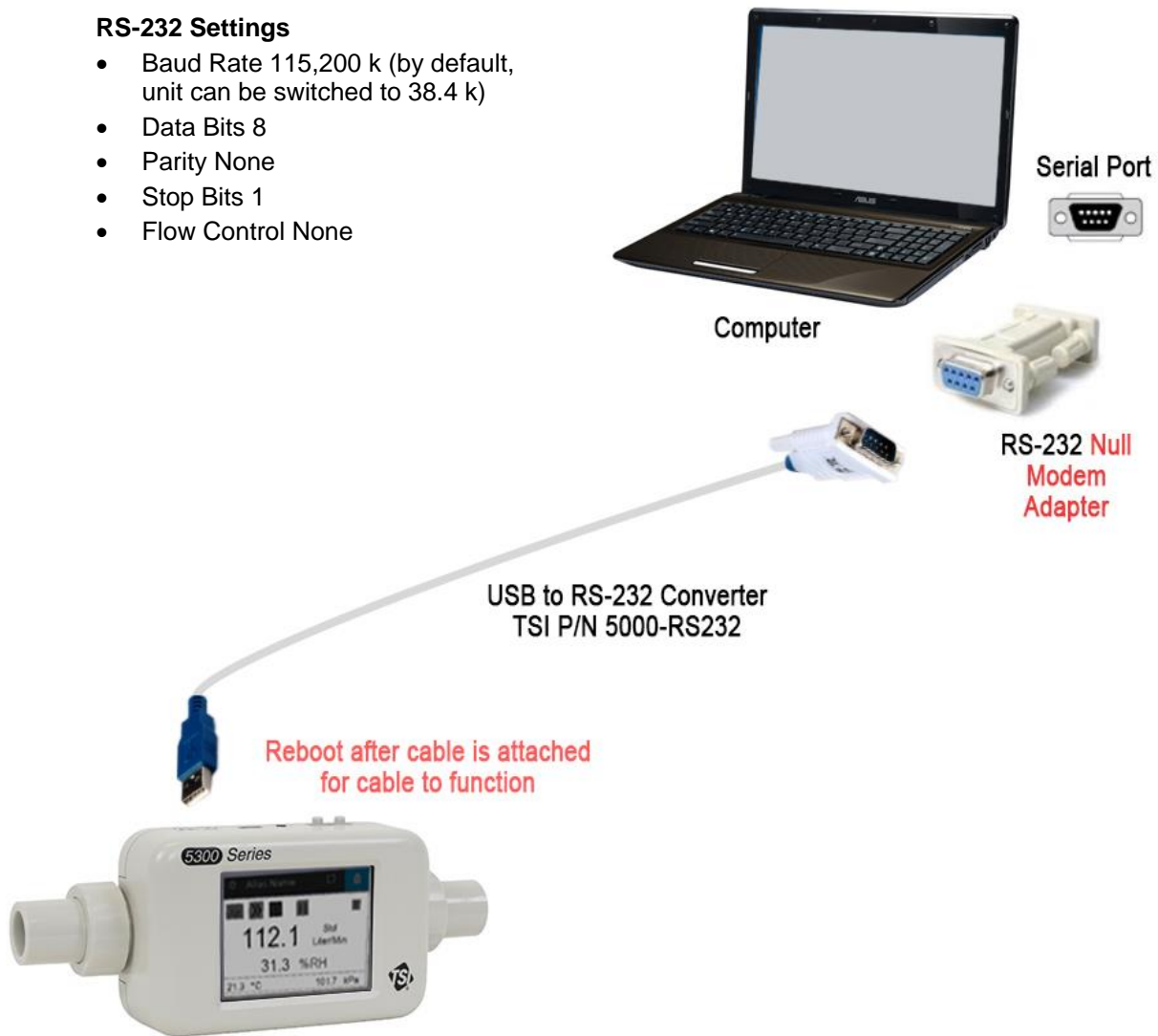

Connecting Inlet Filter

The 5300 Series Gas Flow Multi-Meters have an exposed thermal flow sensor that is highly sensitive to foreign matter and particles within the gas flow. TSI® supplies inlet filters for both low pressure and high pressure applications and recommends that these filters be used at all times while testing with the instrument. After attaching the inlet filter, connect the flow tube to the inlet side of the filter.

If you are measuring a bidirectional gas flow and are concerned about foreign matter or particles entering the flow stream from either side of your test setup, TSI® recommends an inlet filter be placed on both sides of the meter.

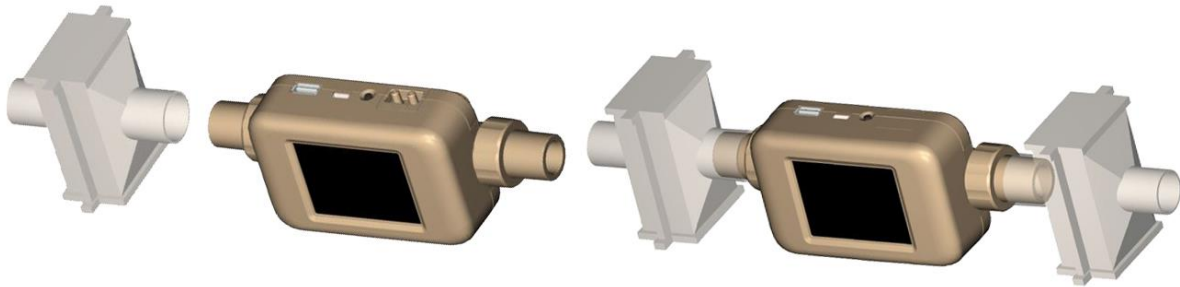

CAUTION

Always use a filter on the inlet of the flow meter. Failure to filter the gas flow may change the calibration and/or permanently damage the sensor.

NOTICE

Connecting a second inlet filter or tube to the outlet side of the 5300 Series Gas Flow Multi-Meter will create back pressure. In general, minimize back pressure on the meter to maintain the highest possible accuracy.

See [Appendix A](#) for the pressure drop created by connecting the supplied inlet filters to the 5300 Series Multi-Meter along with additional specifications.

Changing Tube Ends

The 5300 Series Gas Flow Multi-Meter incorporates interchangeable tube ends that can be easily configured by you without the need for special tools or additional accessories. Follow the step-by-step instructions below to remove and replace the 5300 Series Gas Flow Multi-Meter tube ends.

NOTICE

5200 Series Low Flow Multi-Meter and 5300 Series High Flow Multi-Meter tube ends are not interchangeable.

Step 1: Unscrew and remove the collars then remove the tube ends by pulling them straight out of the meter.



Step 2: Select your desired size of tube ends and insert them into the meter while aligning the anti-rotation notch on the tube end with the tab on the meter.

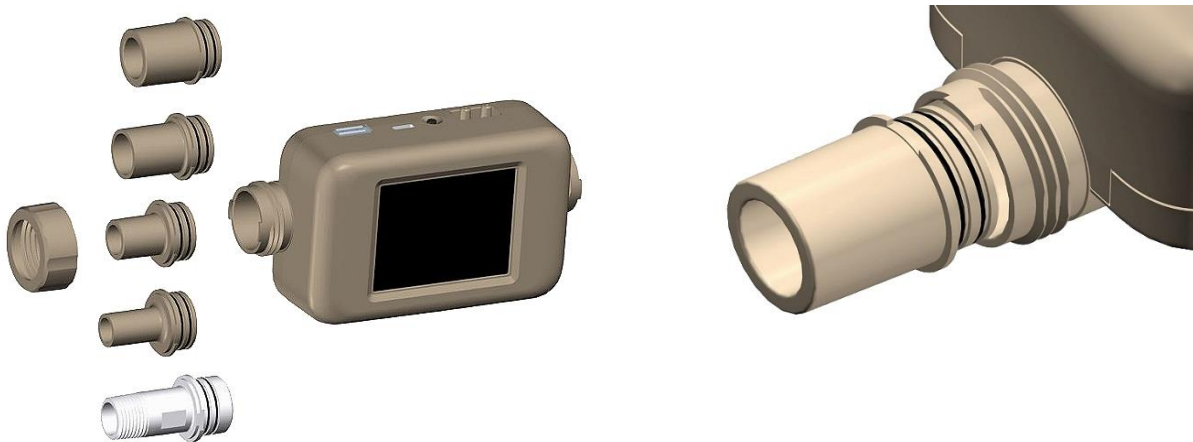

Step 3: After aligning the tube ends into the meter, slide the collars back on and tighten them by rotating clockwise.

NOTICE

Contact [TSI](https://www.tsi.com)[®] if you would like specifications for designing your own custom tube ends.

Using 0.5 inch or 15 mm Tube Ends

When using a 5300 Series meter with 0.5 inch or 15-mm tube end adapters, if the filter is connected as shown right then no further action is needed.

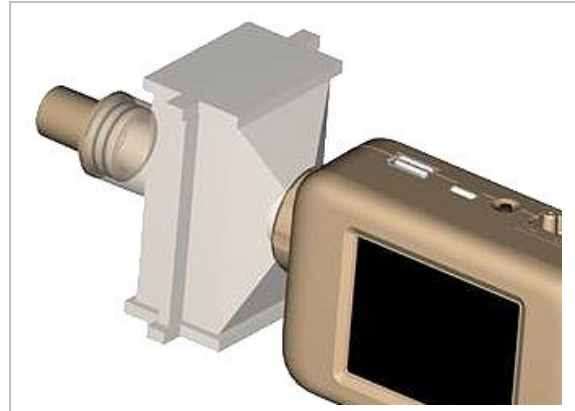

If the 0.5 inch or 15-mm tube ends are connected directly to the instrument, you should select the “Using 0.5 inch or 15 mm ends” Toggle Switch in the meter’s Settings screen.



NOTICE

The 5300 Series Flow Multi-Meter will still measure within its published accuracy specification even if this recommendation is not followed, but selecting the toggle switch with this setup ensures the most accurate flow measurement readings.

This toggle switch can be found by clicking on the **Settings** button in the Menu header.

1. Select the **Config tab**.
2. Click the **Edit** button.
3. Click the toggle switch.
4. Select **Save**.

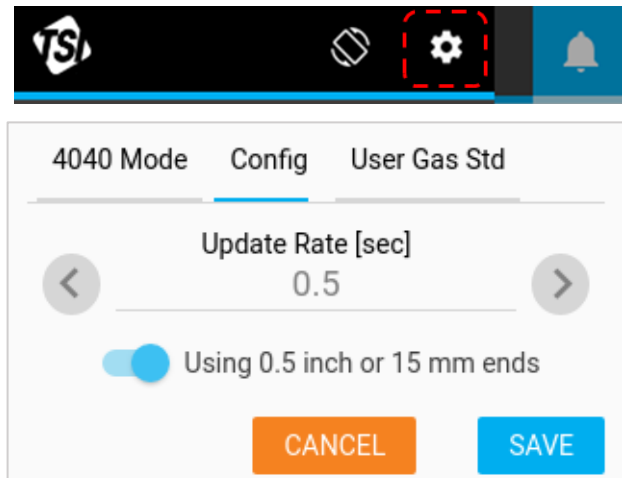

Low Pressure Measurement Kit

TSI® includes a Low Pressure Measurement Kit (5300-LPMK) to utilize the low differential pressure measurement available on models 5310, 5320, and 5330. The kit comes complete with the airway pressure fittings and tubing needed to connect the breathing or test circuit to the Flow Multi-Meter. See below for instructions on connecting the Low Pressure Measurement Kits to the 5300 Series.

NOTICE

TSI® does not require that these kits be utilized to make differential pressure measurements but provides them simply as a convenience.

5300 Series Low Pressure Measurement Kit (5300-LPMK)

Standard Setup: 22-mm ISO Tube Ends

- Step 1:** Locate and attach a 22-mm Airway Pressure Fitting to the outlet side tube end of the 5300 Series Multi-Meter with the barb facing up.
- Step 2:** Measure and cut a length of tubing and connect it from the Airway Pressure Fitting barb to the (+) port on the Multi-Meter.
- Step 3:** Attach a filter (5300-IF-LP) to the inlet side tube end of the Multi-Meter.

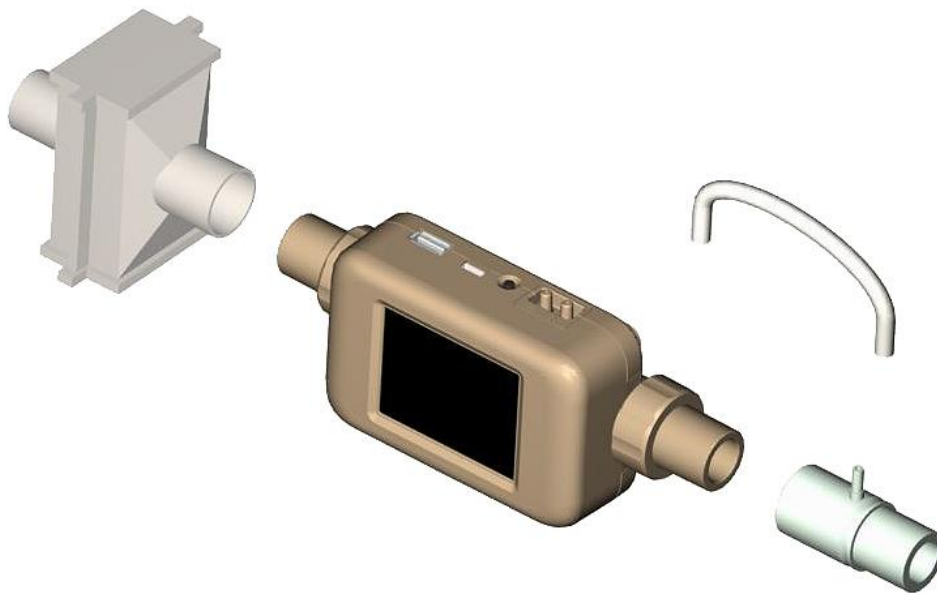

Alternative Setup: 15-mm, 3/4 inch, or 1/2 inch Tube Ends

Step 1: Remove the collars and tube ends from the Multi-Meter and then screw the collars back on.

Step 2: Insert the Airway Pressure Fitting into the outlet side of the Multi-Meter in the inverted direction with the barb facing up.



Step 3: Measure and cut a length of tubing and connect it from the Airway Pressure Fitting barb to the (+) port of the Multi-Meter.

Step 4: Insert the Inlet Filter (5300-IF-LP) supplied in the Standard Accessory Kit into the inlet side of the Multi-Meter in the inverted direction.

Step 5: Insert alternative tube ends into the inlet of the Filter and into the outlet side of the Airway Pressure Fitting.

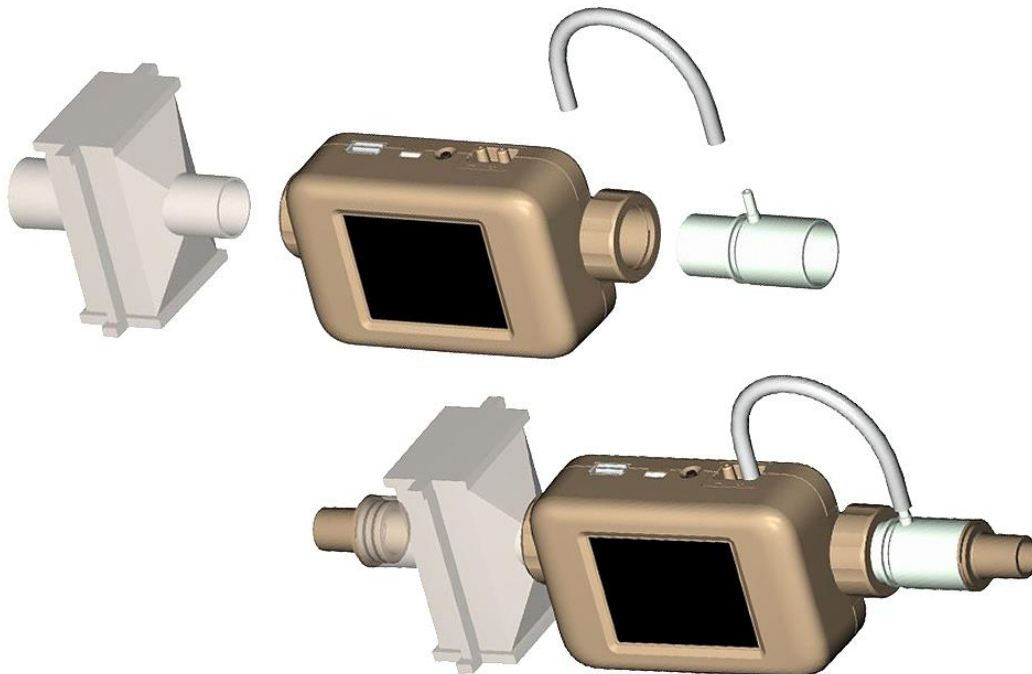

(This page intentionally left blank)

CHAPTER 3

Meter Operation



CAUTION

TSI® flow meters are not medical devices under FDA 510k and in no situation should they be utilized for human respiration measurements.

Getting Started

Power Button

The Multi-Meter may turn itself on once it is supplied with power. If the meter does not turn on automatically, press the Power button on top of the meter and the unit will power **ON**. To turn the instrument **OFF**, press and hold the Power button for 5 seconds.

Initialization and Warm-Up

It takes approximately 40 seconds for the 5300 Series Gas Flow Multi-Meter to initialize and warm-up. A TSI® splash screen will be displayed during this initialization period. Once this process has completed, the Flow Multi-Meter will begin displaying measurements and users will be able to fully operate meter. No additional meter warm-up time is needed.

Touchscreen Display

The 5300 Series meters utilize a 2.8-inch color LCD touchscreen display for easy viewing and operation. The touchscreen display is resistive and responds to pressure applied from a finger, stylus, or other instrument. The Flow Multi-Meter touchscreen can be operated while wearing gloves.

Measurement Parameters

The 5300 Series Gas Flow Multi-Meter measures flow rate, flow volume, temperature, absolute pressure, low differential pressure (Models 5310, 5320, 5330 only), and relative humidity (Models 5320 and 5330 only). All measurements made by the 5300 Series Multi-Meter are NIST traceable.

Flow Measurement

The 5300 Series Gas Flow Multi-Meters incorporate TSI® Incorporated's proprietary platinum film sensor designed for measuring gas flows with high accuracy and fast response time while minimizing the pressure drop. Flow measurements are bi-directional and depending on the model can be selected to measure air, oxygen, air/oxygen mixtures, nitrogen, and carbon dioxide. Flow measurement data is available on the meter, through FLO-Sight™ PC Software, or via ASCII commands.

Meter Orientation

Although the 5300 Series can measure flow in both directions, TSI® recommends that flow be run through the meter from left to right as this is the orientation in which the meter was calibrated. There is an arrow printed on the bottom of the meter for reference.

Flow measured in this direction will be displayed as positive while flow measured in the reverse direction will be shown as negative.



For maximum flow accuracy at low flows, TSI® also recommends that the meter be run in a horizontal orientation.

Temperature Measurement

The 5300 Series Multi-Meters have an independent temperature transducer in the flow tube to measure and display the gas temperature. The temperature sensor is also used for temperature compensation of flow rate and for converting flow from standard to volumetric units. Temperature measurement data is available on the meter, through FLO-Sight™ PC Software, or via ASCII commands.

NOTICE

At low flow rates, the temperature inside of the flow tube will increase because of the heat generated by the thermal flow sensor. This effect is normal and the temperature of the incoming gas will be measured once flow resumes.

Absolute Pressure Measurement

The 5300 Series Multi-Meters measure absolute or barometric pressure near the outlet of the flow path. This pressure measurement is required for converting standard flow to volumetric flow. Absolute pressure measurement data is available on the meter, through FLO-Sight™ PC Software, or via ASCII commands.

Low Differential Pressure Measurement

Models 5310, 5320, and 5330 Gas Flow Multi-Meters have the ability to measure differential pressure, also known as breathing circuit pressure. The pressure differential of flows can be measured at the meter or at any point along the circuit. Low pressure measurement data is available on the meter, through FLO-Sight™ PC Software, or via ASCII commands. When combined with absolute pressure, low pressure readings can be used to calculate a volume flow rate at a remote point in the system. See Appendix D for more information on [Remote Flow Measurements](#).

Relative Humidity Measurement

Models 5320 and 5330 Gas Flow Multi-Meter includes a relative humidity sensor near the inlet of the flow path. In addition to providing a humidity measurement, sensor readings are used to compensate the air flow for humidity effects to provide an equivalent dry-gas flow measurement. Relative humidity measurement data is available through the meter, FLO-Sight™ PC Software, or via ASCII commands.

NOTICE

Humidity compensation does not apply to oxygen or carbon dioxide gas flows.

Volume Measurement

5300 Series Gas Flow Multi-Meters measure total volume by integrating flow over time. This is a calculated measurement performed by the Multi-Meter and is controlled through triggers. You can set begin and end triggers for volume measurements using flow rate, absolute pressure, or low differential pressure values.

See the topic "[Volume and Triggers](#)" in Chapter 4 of this manual for more information on triggering and volume measurements. For models 5310, 5320, and 5330 you can set triggers and take volume measurements through the meter or with FLO-Sight™ PC Software. Volume measurements are available via ASCII commands for all 5300 Series models.

Totalizer Measurement

All 5300 Series Gas Flow Multi-Meters include a totalizer feature that measures total volume by integrating flow over time. This is a calculated measurement performed by the meter and operates as a running total. The totalizer count begins automatically when the meter is powered on regardless if the totalizer parameter is displayed or not. You can reset the totalizer count back to zero within the meter. Totalizer measurements can be viewed on the meter and in FLO-Sight™ PC Software.

Units of Measurement

The 5300 Series Gas Flow Multi-Meter allows for user-selectable units of measurement options for all available measurement parameters. Units of measurement can be configured directly through the meter or with FLO-Sight™ PC Software. Please see "[Configuring the Meter](#)" in Chapter 4 for instructions on changing units.

The table below outlines the default units and optional user-selectable units for each measurement parameter.

Measurement	Factory Default Units	Optional User-Selectable Units
Flow	Liters per Minute (L/min)	Cubic Feet per Minute (ft ³ /min)
Flow Gas Standard	Standard (Std)	Volumetric (Vol) Actual (Act) Remote (Rem)
Temperature	Degrees Celsius (°C)	Degrees Fahrenheit (°F) Kelvin (K)
Absolute Pressure	Kilopascals (kPa)	Pascals (Pa) Hectopascals (hPa) Millibars (mbar) Pounds per Square inch (PSI) inches of Water (inH ₂ O) Centimeters of Water (cmH ₂ O) Millimeters of Mercury (mmHg)
Low Pressure (5310, 5320, 5330 models only)	Centimeters of Water (cmH ₂ O)	Pascals (Pa) Hectopascals (hPa) Kilopascals (kPa) Millibars (mbar) Pounds per Square inch (PSI) inches of Water (inH ₂ O) Millimeters of Mercury (mmHg)
Relative Humidity (models 5320, 5330 only)	Percent Relative Humidity (%RH)	Temperature Dew Point in Degrees C (TdpC) Temperature Dew Point in Degrees F (TdpF)
Volume	Liters (L)	Milliliters (mL) Cubic Feet (ft ³)
Totalizer	Liters (L)	Milliliters (mL) Cubic Feet (ft ³)

Type of Gas

The 5300 Series is capable of measuring Air, Nitrogen, Oxygen, Air/Oxygen Mix, or Carbon Dioxide depending on the model. Flow meter models with an air calibration also include nitrogen correction as a gas type option. You can select the type of gas to be measured from the available gas calibrations on your meter. The type of gas can be set on the meter directly, through FLO-Sight™ PC Software, or via ASCII commands.

Model Numbers based on Gas Calibration

	Air, N ₂	Air, O ₂ , Air/ O ₂ Mix, N ₂	Air, CO ₂ , N ₂	O ₂ Only	CO ₂ Only
5300 Series	5300-1	5300-2	5300-3	5300-4	5300-5

Meter Configuration

The 5300 Series Multi-Meter enables you to select measurement parameters to display, units of measurement, and the type of gas to be measured directly from the meter's touchscreen display.

There is an option to lock the meter which restricts you from changing measurement settings directly from the Meter Home Screen. The lock function is set to disabled as its default so that measurement settings can be changed freely.

If the lock function is enabled, you must unlock the meter before you can make changes to measurement settings on the Meter Home Screen. You can lock and unlock the screen through the meter itself, but the lock function can only be enabled and disabled through FLO-Sight™ PC Software.

See "[Configuring the Meter](#)" in Chapter 4 for step-by-step instructions on configuring the meter through the touchscreen display. Additional settings can be configured using FLO-Sight™ software or with ASCII commands.

Data Logging

Series 5300 Multi-Meters can save measurement data on their internal memory which can be exported for viewing and analysis. Data can be logged for the flow rate, low pressure, temperature, absolute pressure, and humidity (if available) measurement parameters.

Models 5310, 5320, and 5330 enable you to configure logging parameters and initiate data log sessions directly from the meter. See "[Data Logging](#)" in Chapter 4 for instructions on logging data through the meter. Data logging can also be done with the advanced version of FLO-Sight™ PC Software for all 5000 Series models. Please refer to the *FLO-Sight™ PC Software Manual* for more information.

The table below shows the preset data logging configurations available on the meter and specifies the number of sample points collected for each configuration. The maximum number of sample points per log file when logging through the meter is 15,000. A blank field indicates the configuration is unavailable from the touchscreen display. For example, the box for a 1 second Test Length @ 100 ms Sample Time Intervals is blank and is therefore unavailable on the meter.

Preset Logging Configurations and Sample Points

Sample Time Interval	Test Lengths							
	1 sec	5 secs	15 secs	1 min	10 mins	1 hour	5 hours	24 hours
1 ms	1000	5000	15000					
5 ms	200	1000	3000					
100 ms		50	150	600				
1 second				60	600	3600		
5 seconds					120	720	3600	
1 minute						60	300	1440
5 minutes						12	60	288

NOTICE

Sample time intervals and test lengths can be customized with FLO-Sight™ PC Software. The maximum number of sample points per log file is 100,000 when logging through FLO-Sight™ PC Software.

Touchscreen Navigation

Display Overview

Meter Home Screen

Upon startup, the home screen of the meter will be loaded. The home screen is where you will see real-time data for multiple measurements, interact with the display, and make changes to the meter through the settings menu.

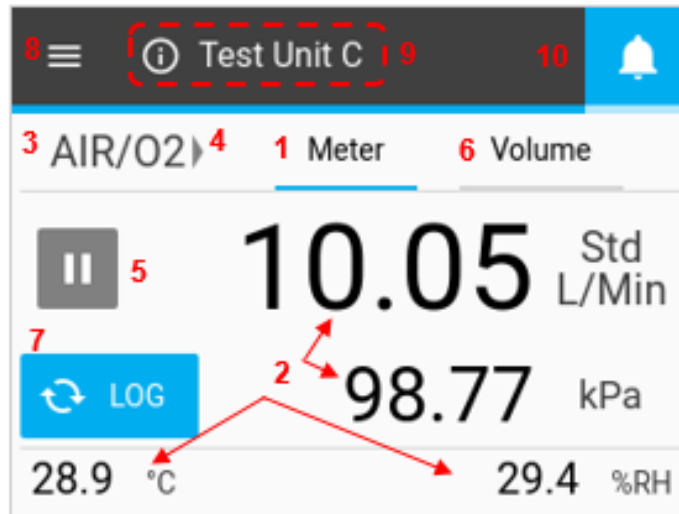

1. Meter Home Tab	6. Volume and Triggers Tab *
2. Measurement Readings	7. Log Data Button *
3. Type of Gas	8. Menu Drop-down Screen
4. Flow Directional Indicator	9. Device Name and Information
5. Pause Display Button	10. Alerts Indicator

*Available on 5310, 5320, and 5330 models only

Menu Screen

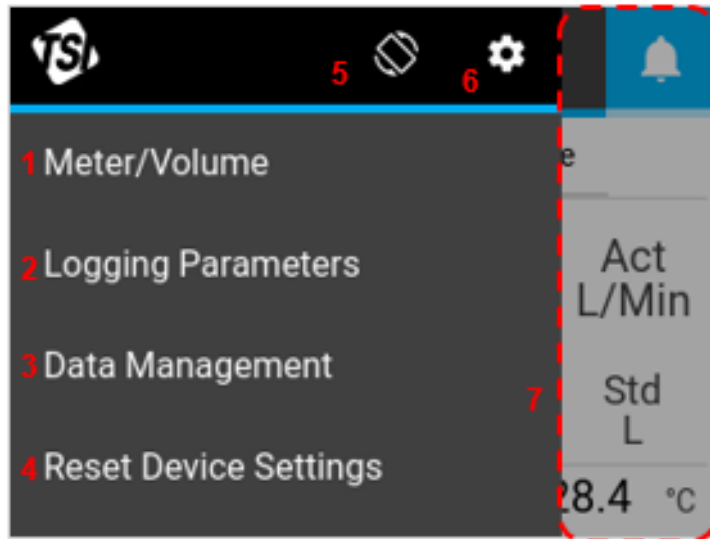

1. Go to Meter Home Screen	5. Rotate Display 180°
2. Set Logging Parameters *	6. Settings Menu
3. Data Management *	7. Press anywhere outside menu to close menu screen
4. Reset Device Settings	

*Available on 5310, 5320, and 5330 models only

Measurements

Up to four measurement parameters can be displayed simultaneously on the home screen. You can configure the fields to display any available measurement parameters as well as change units of measurement.

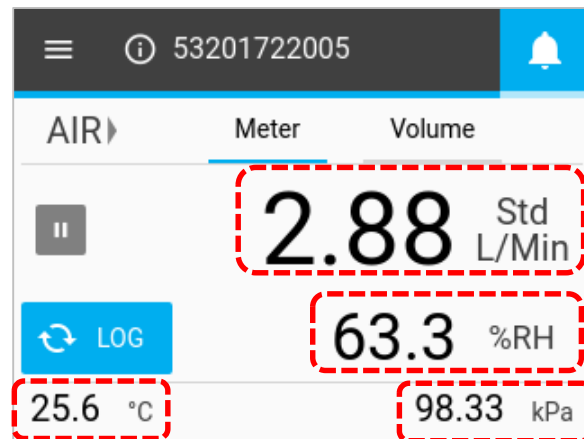

Type of Gas

The Meter Home Screen displays the active gas calibration for the Flow Multi-Meter. Certain models may be calibrated for a single gas while others may be calibrated to measure multiple gases. The type of gas can be changed after unlocking the meter for configuration. See "[Configuring the Meter](#)" in Chapter 4 for instructions on changing the gas type.

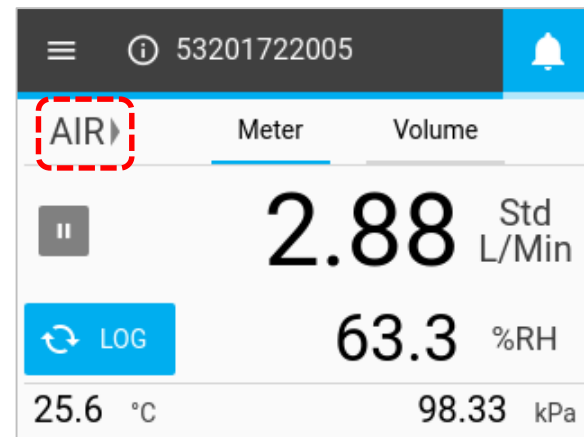

Flow Directional Indicators

On either side of the “**Type of Gas**” field, arrows point in the direction of gas flow through the meter and correspond with changes in the direction of flow. In the default bidirectional mode, flow moving from left to right → through the meter is shown as positive. Flow moving from right to left ← through the meter is shown as negative. If the flow is zero, no indicator arrows will be displayed.

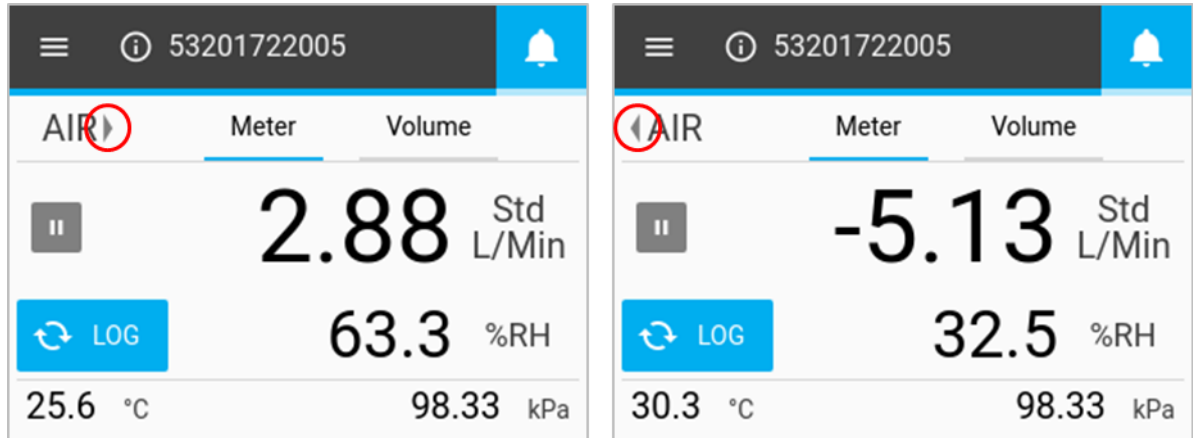

Pause/Play Display

The **Pause** button is used to pause the display from updating. When the **Pause** button is pressed, the current measurement values will remain fixed on the screen. The meter will continue to make measurements while paused, and pausing the display does not affect any active datalog sessions.

When paused, the button's icon will change to a green play icon and the display function will become disabled (grayed out). Press anywhere on the screen to re-enable display functionality. To un-pause the display and resume screen updates, press the **Play** button.

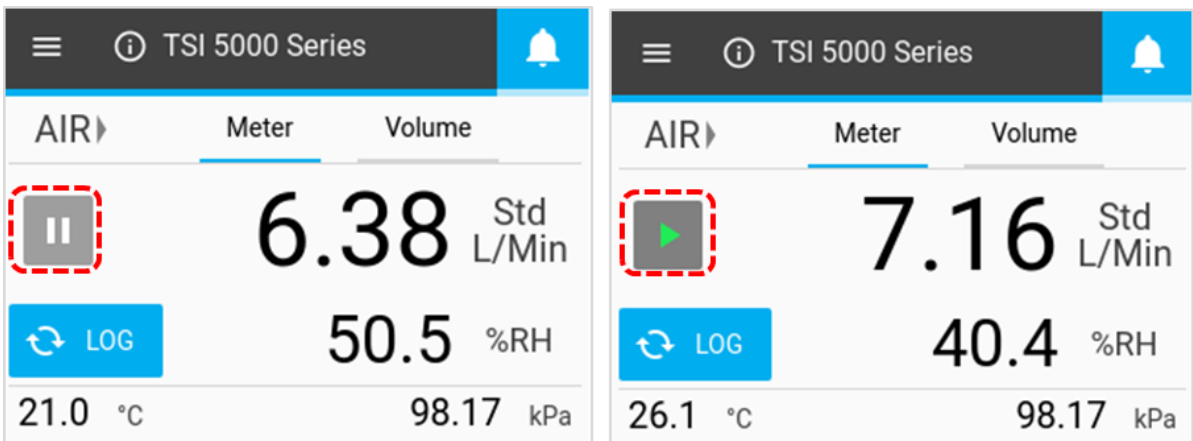

Configuring the Meter

On the Meter Home Screen you can change the measurement parameters, units of measure, and the type of gas to be measured. Changes can be made on the **Meter** tab and the **Volume** tab (if available).

Measurement Parameters

Press a value field, use the scroll arrows to select a parameter, and click **Save**.

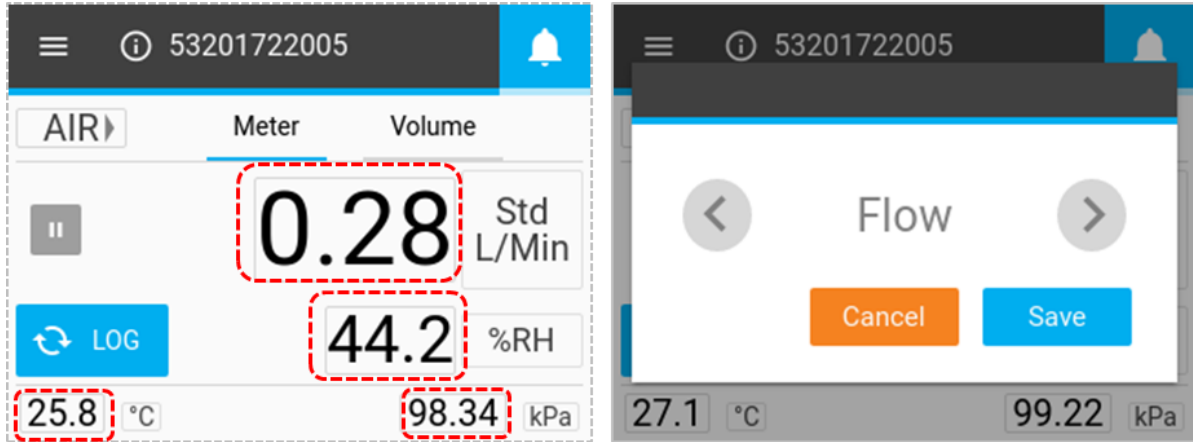

Units of Measurement

Press a units field, use the scroll arrows to select the desired units, and click **Save**.

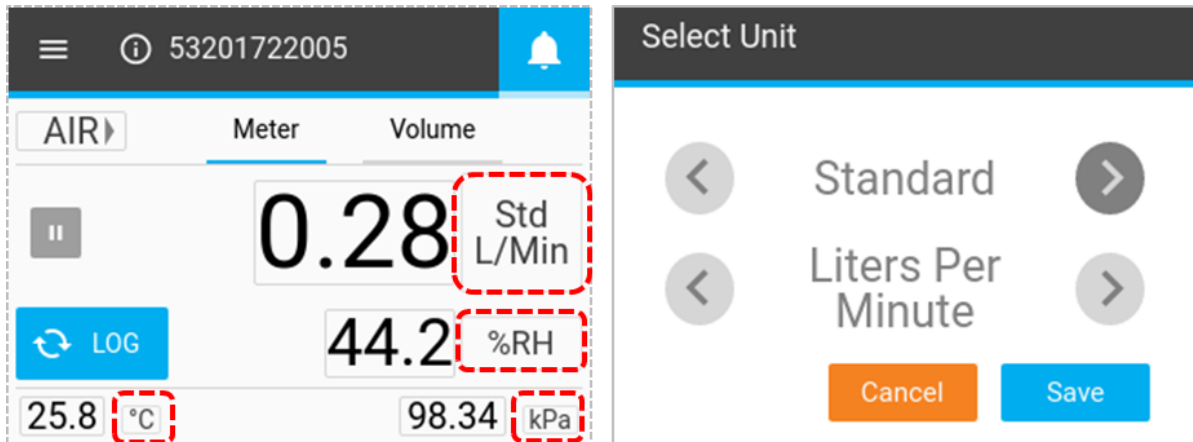

Flow Conditions

When **Flow** is selected as a measurement parameter, you have the option to select how the flow measurement is calculated and displayed. These options are available in the **Select Unit** dialog box that appears when the Units of Measurement field is pressed for a flow measurement.

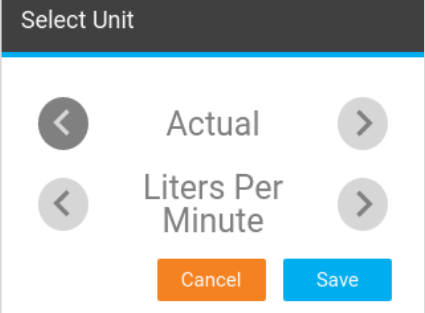
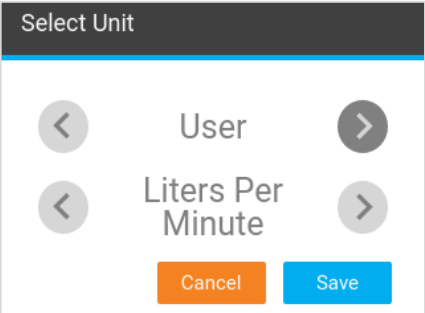
Standard	This is flow rate the air would be moving if the temperature and pressure were at standard conditions. For TSI® instruments, standard conditions are defined at 21.1°C (70°F) and 101.3 kPa (14.7 psia).	
Actual	This uses the actual temperature and pressure of the gas to deliver the volumetric flow rate. This is the true volume flow of the gas exiting the flow meter.	
User	This factor allows you to apply your own temperature and pressure conditions to the gas flow. You can specify these conditions with FLO-Sight™ PC Software.	
Remote	This option allows you to calculate volume flow rate at a remote point in the system using the absolute pressure and differential pressure measurements. See Appendix D for more information on Remote Flow Measurements .	

Type of Gas

Press the type of gas field, use the scroll arrows to select the type of gas, and click **Save**.

NOTICE

If an Air/Oxygen mix is selected, the meter assigns a 21% oxygen mix. The oxygen concentration can be customized using FLO-Sight™ PC Software.

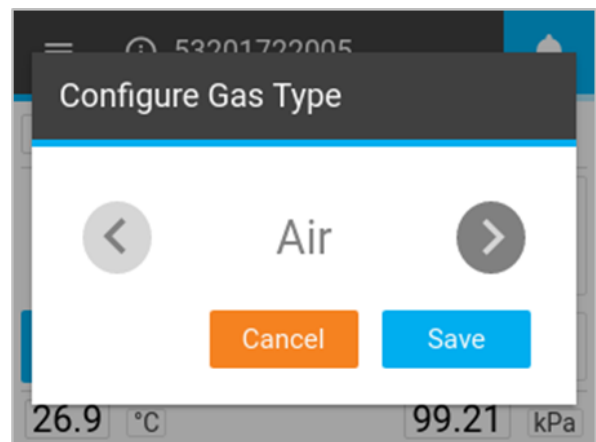
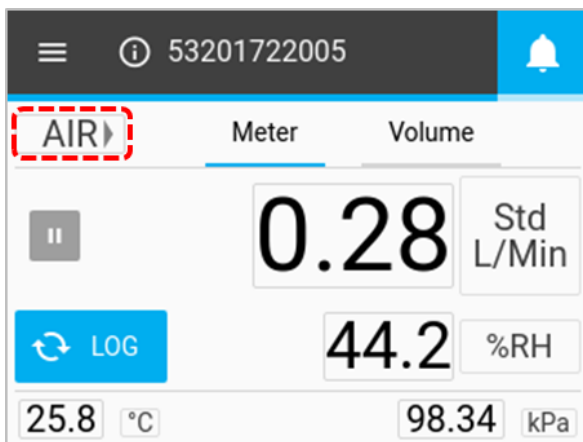

Locking the Meter

There is an option to lock the meter which restricts you from changing measurement settings directly from the Meter Home Screen. With the lock function enabled, you must unlock the meter before you can make changes to measurement settings on the Meter Home Screen.

You can lock and unlock the screen through the meter itself, but the lock function can only be enabled and disabled through FLO-Sight™ PC Software. The lock function is set to disabled as its default so that measurement settings can be changed freely.

Enable Meter Locking

To enable the locking function, connect the meter to FLO-Sight™ PC Software, click on the menu icon in the software and select **Settings**. Make sure the device you want to configure is selected, press the **Edit** button, click the **Device Lock** toggle switch, and press **Save**. The meter is now locked and you will not be able to change measurement parameters, units of measurement, or the gas type without first unlocking the meter.

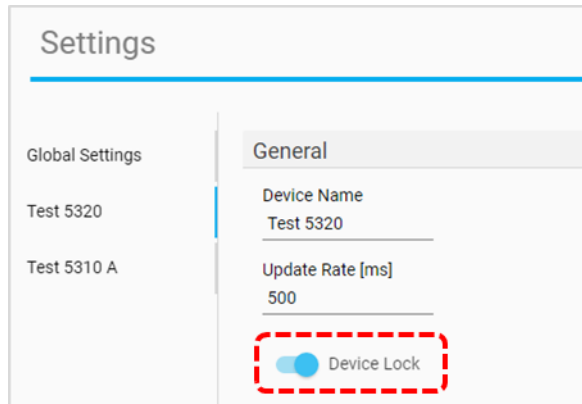

Unlock / Lock the Meter

Once the lock function is enabled through FLO-Sight™ PC Software, a lock icon will become visible in the Menu header of the Flow Multi-Meter. You now must first unlock the meter before you can configure measurement settings on the Meter Home Screen.

To unlock the meter, select the Menu drop-down on the home screen then select the **Lock** icon in the Menu header. Once unlocked, the lock icon will change to an open lock and you can freely change measurement settings on the Meter Home Screen.

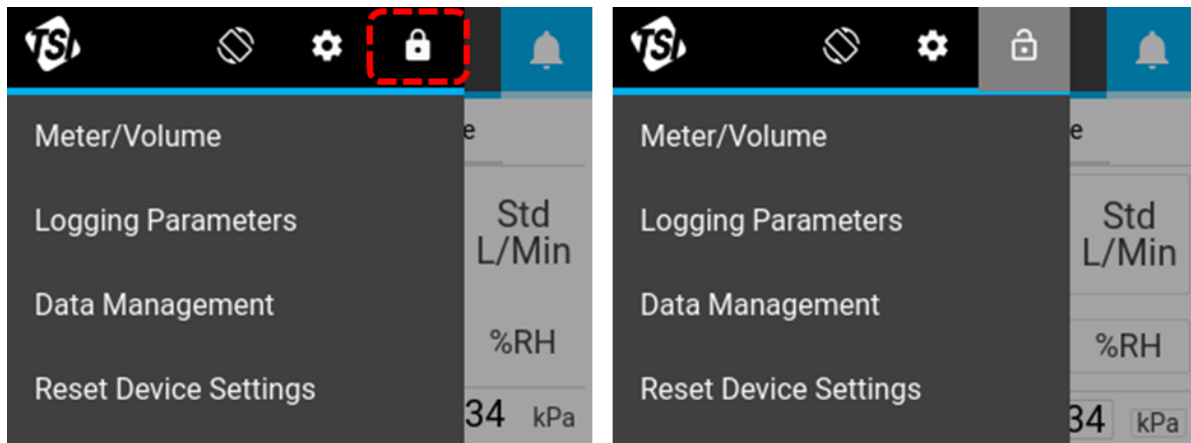

With the meter unlocked, navigate back to the Meter Home Screen by selecting **Meter/Volume** from the menu. The fields unlocked for configuration on the Meter Home Screen will have a gray box displayed around them.

The meter will remain unlocked and open for changes until you lock the meter. To lock the meter and restrict changes to the Meter Home Screen, navigate to the Menu drop-down and press the **Lock** icon. Once locked, the lock icon will change to back closed and you will no longer be able to change measurement settings on the Meter Home Screen.

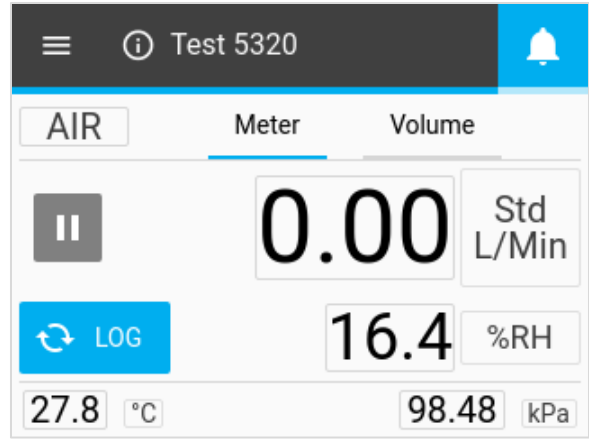

Volume and Triggers

Volume is a calculated measurement that integrates flow over time and is controlled through triggers. This feature is available through the meter for models 5310, 5320, and 5330 only and is located on the **Volume** tab of the meter. You can control your volume measurements by selecting the trigger parameter, trigger mode, and begin/end trigger values.

The graphic below shows conceptually how volume is measured between two trigger levels.

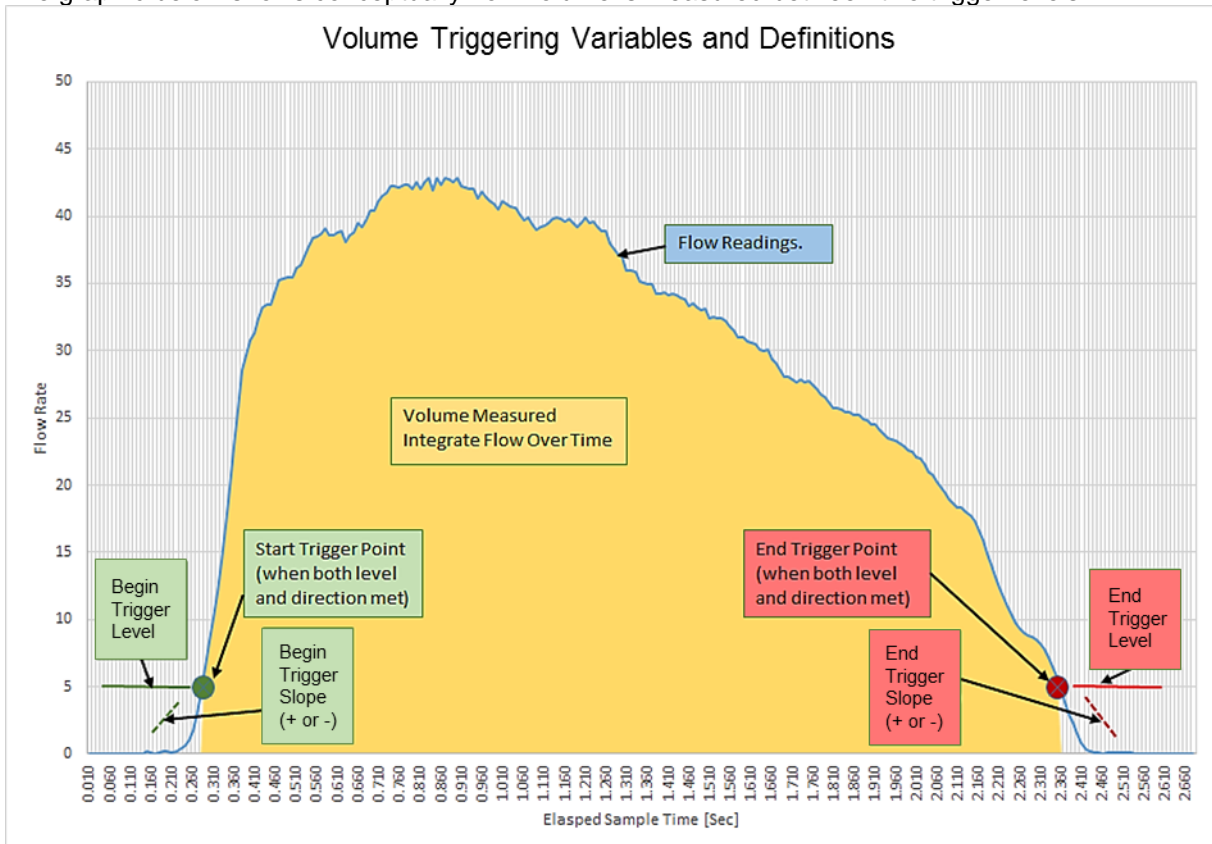

Setting Triggers

The meter must be stopped to edit trigger settings. On the **Volume** tab, confirm that the meter is stopped (shown below left) and press on the field you would like to edit.

If a volume measurement is active (shown below right), then press the **Stop**  button to cancel the measurement and allow edits to be made to trigger settings.

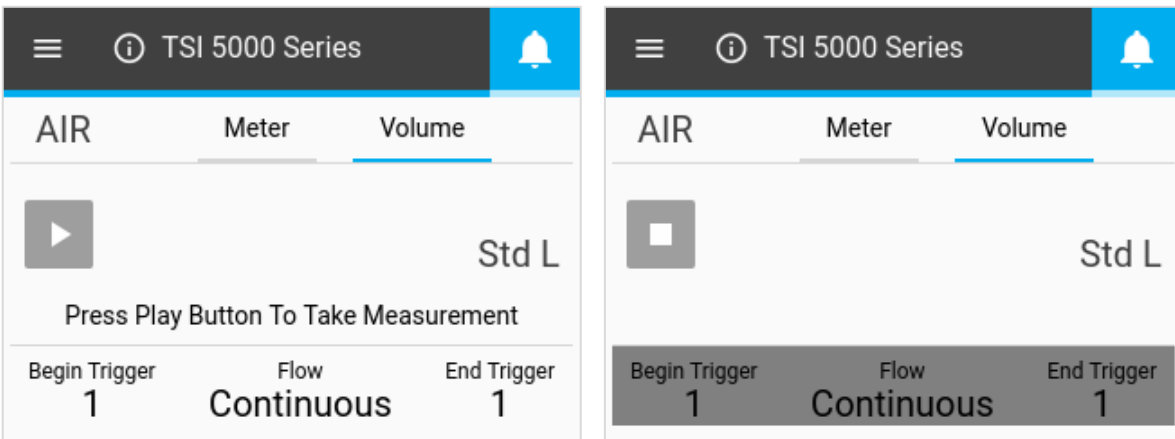

Select Mode

With the volume screen stopped, press the middle fields to bring up the Select Mode dialog box. In this screen you can choose your Trigger Parameter (Flow, Absolute Pressure, or Low Differential Pressure) and Test Mode (Single or Continuous testing). Use the arrows to scroll through the selection options and click **Save** to complete.

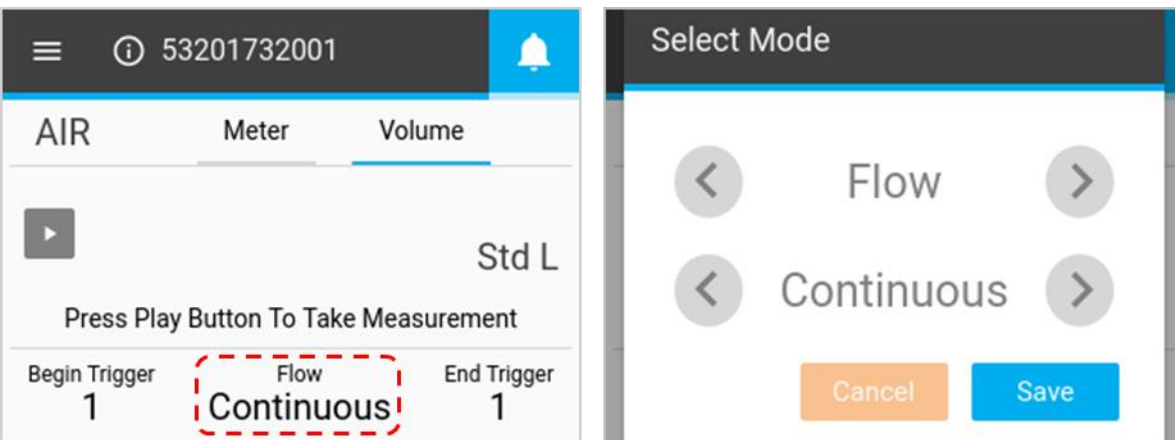

Trigger Parameter	Flow, Absolute Pressure, or Low Pressure
Test Mode	Single or Continuous

Single Test Mode: You must press the **Play** button before each volume measurement is taken.

Continuous Test Mode: The meter will continually make volume measurements each time the begin trigger condition is met.

Begin/End Triggers and Slope

With the volume screen stopped, press the fields that you would like to edit. In the Select Trigger and Slope screens, you can select your Begin Trigger or End Trigger values and the Slopes of the triggers. Use the arrows to scroll and select your Trigger Values and the Slopes of the values (Positive or Negative). Once you have made your selections, click the **Save** button.

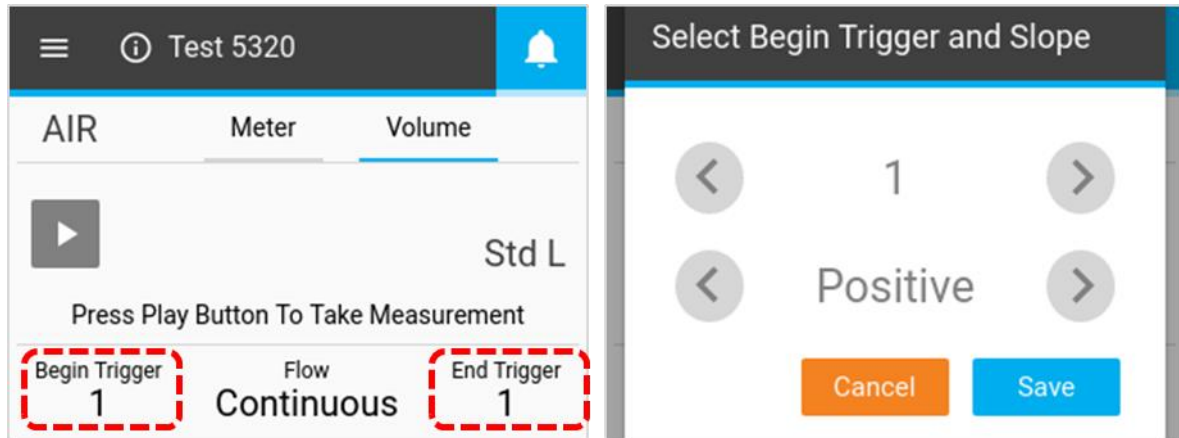

Begin / End Trigger Values	Select from available values
Begin / End Trigger Slopes	Positive or Negative

The slope of the trigger is the direction of the trigger parameter measurement reading as it passes the trigger value as defined by you. A positive slope is ascending measurement readings (ex. 1, 2, 3, 4) and a negative slope is descending readings (ex. 4, 3, 2, 1).

Please note the trigger options for the volume begin and end triggers. These are set as the default options and cannot be changed by you.

Trigger	Units	Trigger Values
Flow	Std L/min	+/- 0.1, 0.5, 1, 2, 3, 5, 7.5, 10, 20
Absolute Pressure	kPa	90, 95, 98, 100, 102, 104, 107, 110
Low Differential Pressure	cmH ₂ O	+/- 0.5, 1, 2, 3, 4, 5, 10

Making Volume Measurements

Once all settings have been saved, press the **Play** button to lock trigger settings and begin making volume measurements.

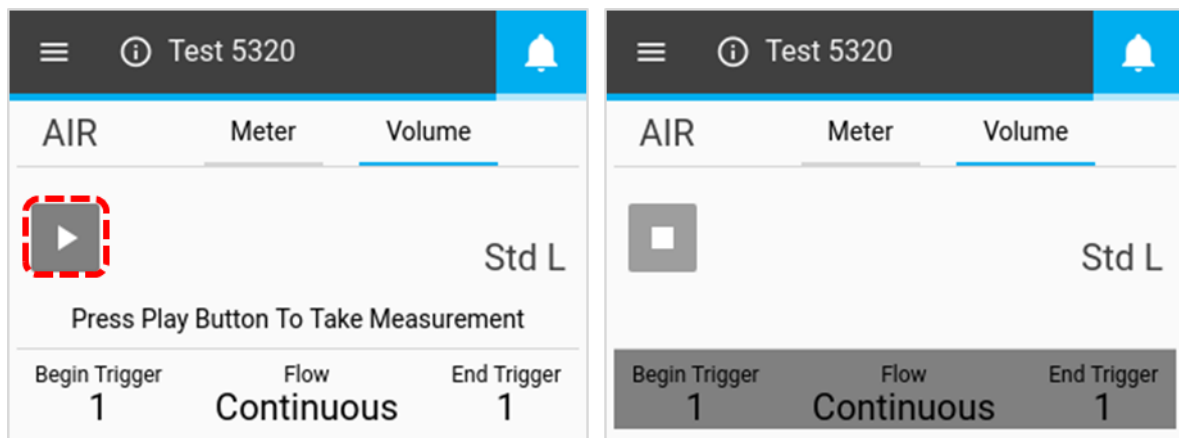

Once the **Play** button is pressed to take measurements, the Flow Multi-Meter will notify you on screen when the Begin Trigger, and then End Trigger, is reached. After the end trigger is reached, the meter will display the calculated volume measurement.

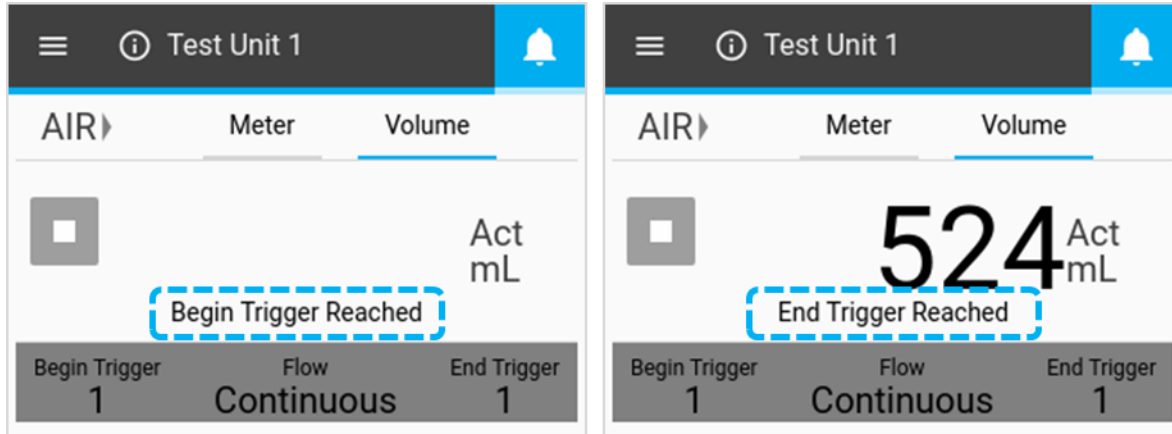

Data Logging

Models 5310, 5320, and 5330 enable you to configure logging parameters and initiate data logging sessions directly from their Flow Multi-Meter. On the Meter Home Screen of these models, a Log button will be visible. In the Menu drop-down screen, these models will display options for “**Logging Parameters**” and “**Data Management**.”

Logging Parameters

From the Meter Home Screen, press the **Menu** button and select **Logging Parameters** from the drop-down menu. In the Logging Parameters screen, use the scroll arrows to select the Sample Time (aka sample rate) and Test Length for data logs. The Log Name is automatically generated for each data file (ex. Log 1, Log 2, Log 3...). Once selections have been made, click on **SAVE**.

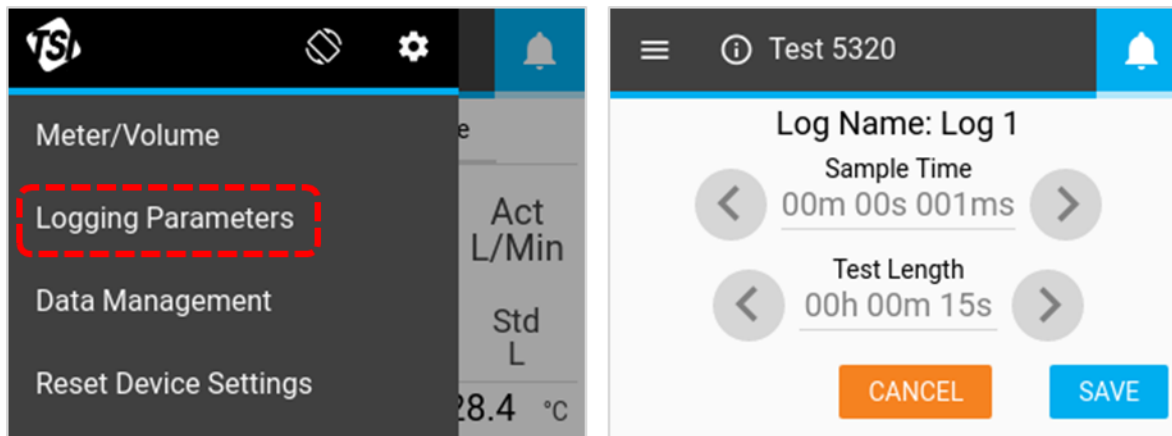

Sample Time

The sample time determines the rate at which the Flow Multi-Meter will store measurement data points. All data points are the average of 1 ms readings. For example, a 50 ms sample rate would log 20 data points per second with each data point being comprised of the average of 50 one-millisecond readings.

Test Length

The test length determines the duration of the data logging session.

NOTICE

The Sample Time and Test Length fields are interrelated, and changing the option for one may result in the option changing for the other. The maximum number of sample points per log file when logging through the meter is 15,000. See the table “[Preset Logging Configurations and Sample Points](#)” in Chapter 3 of this manual for more information. Custom sample times and test lengths can be specified when logging data through FLO-Sight™ PC Software. The maximum number of sample points per log file is 100,000 when logging through the software.

Log Data

To log data, press the **LOG** button from the Meter Home Screen. Once pressed, the Log button will turn green and a clock will count down the test length time. After the logging session is complete, a log file will be created and the log button will return to its normal state.

To stop an active data logging session, press the green data logging countdown button and select **Stop**. No data file is created when a logging session is stopped.

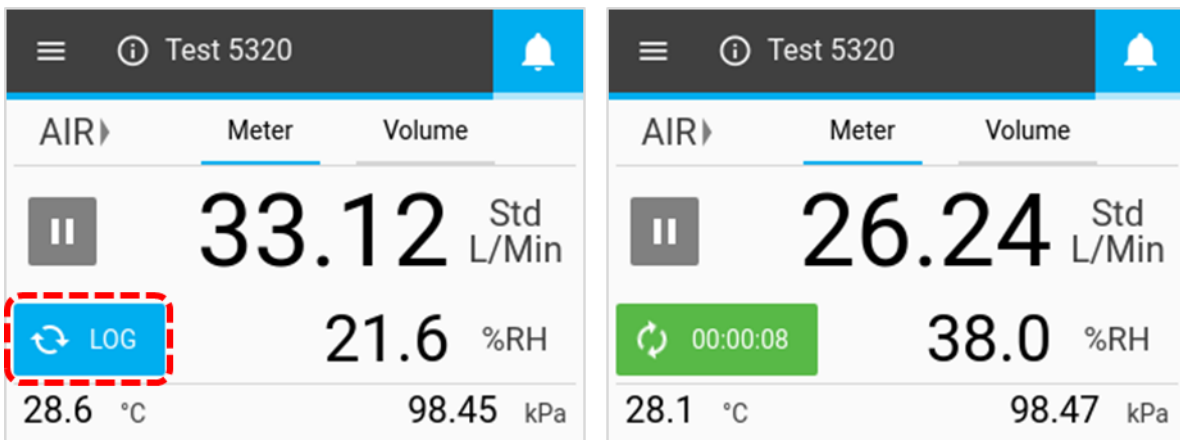

NOTICE

The meter will log data for all available measurement parameters (not including volume or totalizer measurements) regardless of what is displayed on the screen.

Export Data Files

Logged data is saved in the meter's internal memory with each logging session creating a new file. To export data files, insert a USB flash drive into either of the meter's USB-A ports, press the **Menu** button from the Meter Home Screen, and select **Data Management** from the drop-down menu. The Data Management screen displays the number of logged data files stored on the meter. A maximum of 20 datalog files can be stored on the Flow Multi-Meter.

Select **EXPORT** to copy all stored datalog files onto the inserted USB flash drive.

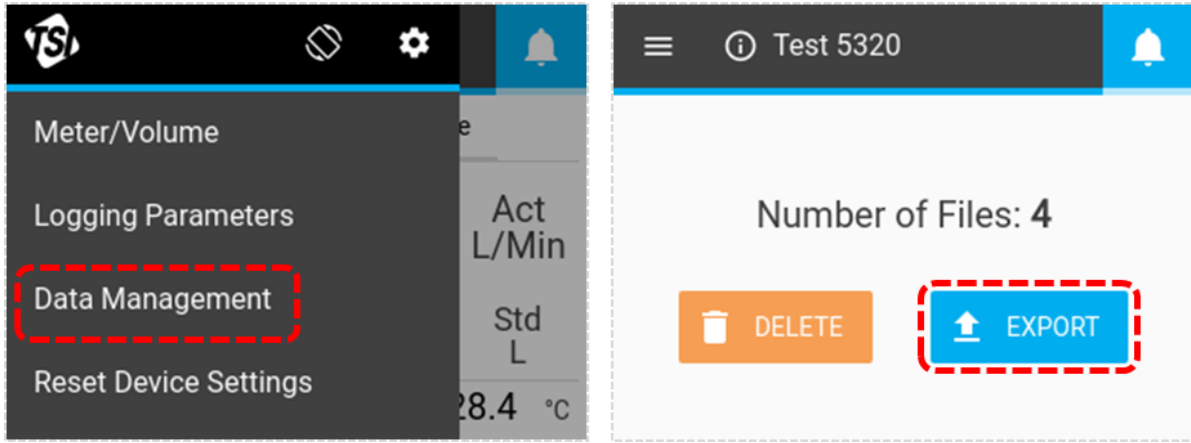

Exported data log files are saved in .csv format. Once on the flash drive, you can edit file names, transfer the files to other devices, or delete the files at your discretion. In addition to measurement readings, the .csv file (shown below) contains information about the meter, data logging parameters, and gas conditions.

	A	B	C	D	E	F
1	Device Model	5320				
2	Serial Number	53201821003				
3	Device Name	53201821003				
4	Log Name	Log 1				
5	Gas Calibration	air				
6	Air/O2 Mixture	N/A				
7	Humidity Comp	Yes				
8	Bidirectional Flow	Yes				
9	User Gas Standard (Temp)	21.11				
10	User Gas Standard (Pres)	101.3				
11						
12	Time	Flow	Humidity	Temperature	Absolute Pressure	Low Pressure
13	[Second]	[Standard L/min]	[RH]	[C]	[kPa]	[cmH2O]
14	0.1	-0.0966	43.3785	31.101	98.3291	-0.0703
15	0.2	-0.0361	43.4023	31.0961	98.3485	0.0198
16	0.3	-0.0247	43.5093	31.0344	98.3743	-0.0732

Delete Data Files

To delete logged data files, select **Data Management** from the Menu drop-down and press the **DELETE** button. This will delete all files from the device; individual files cannot be deleted through the meter.

NOTICE

Additional data management functionality is available through FLO-Sight™ PC Software.

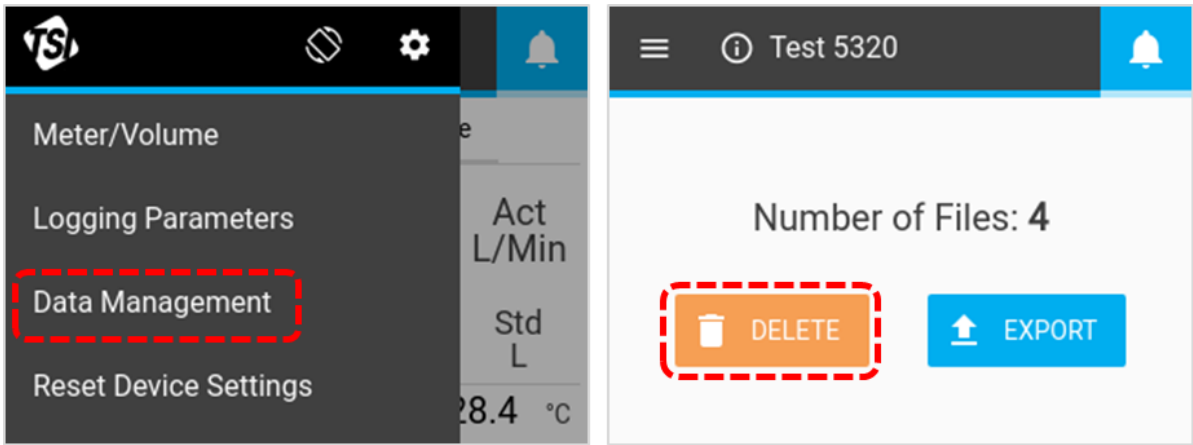

Rotate Screen

You can rotate the screen of the 5300 Series Flow Multi-Meter to make it easier to view readings during challenging test setups. The **Rotate Screen** icon is located in the Menu Header, and when pressed, will rotate the meter's screen 180 degrees.

NOTICE
Directional flow indicators will remain unchanged.



Alerts

The Series 5300 Flow Multi-Meter can display alert conditions when user-set thresholds for a specified parameter are met. Alerts can only be set through the advanced version of FLO-Sight™ PC Software.

When an alert threshold is met, the Bell icon on the meter will turn orange. The value of the parameter that caused the alert will also turn orange. When the threshold is no longer met, the alert will cease and the colors will change back to normal.

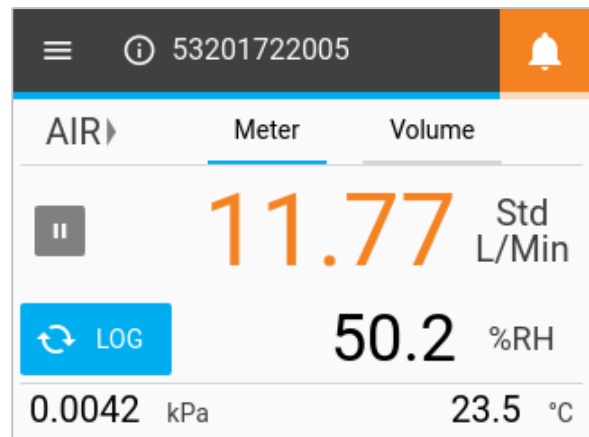

Meter Information

Pressing the Information icon or Device Name on the Home Screen will display information about the meter.

Device Name

The name of the device is displayed in the Header Bar on the Home Screen with the text “TSI 5000 Series” as the default text. The device name can be edited through FLO-Sight™ PC Software only. Select the **DONE** button to return to the Home Screen.

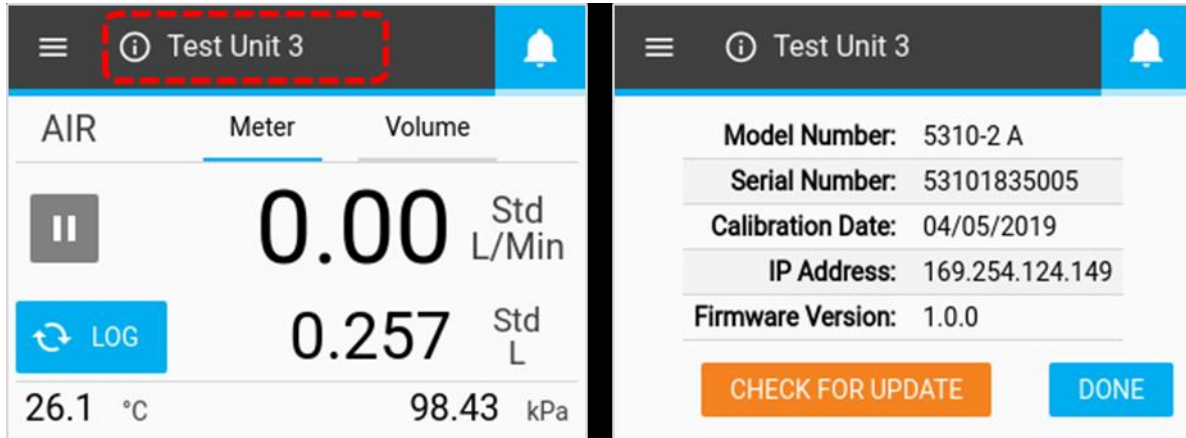

Model Number

This field displays the model number of the instrument (ex. 5310). The dash number is the gas calibration of the meter (ex. -2 above indicates Air/O₂ calibration). There will be a letter or number after the model-dash number that represents the hardware revision (ex. “A” in the above screenshot).

Serial Number

This is the serial number of the meter. The naming convention is as follows: 5XXX YYWW XXX

5XXX =	Model Configuration (ex. 5320)
YY =	Year of Manufacture
WW =	Week of Manufacture
XXX =	Manufactured Unit Number

Calibration Date

This is the date that the instrument was last calibrated by TSI®. TSI® recommends an annual calibration for all flow meters.

IP Address

Each 5300 Series Flow Multi-Meter will have its own unique IP address. The IP address can be used in establishing communication with a computer and communicating via ASCII commands. Please see the *Series 5200/5300 ASCII Command Set Manual* for more information on communicating with ASCII commands.

Firmware Version

This field displays the current firmware version being used by the Flow Multi-Meter. Firmware updates can be uploaded through the USB-A port of the meter. The **Check for Update** button on the Meter Information screen is used to load firmware updates from an inserted USB drive.

Updating Firmware

TSI® may periodically release firmware updates for the 5000 Series. These update utilities can be downloaded from www.tsi.com and then installed on the Flow Multi-Meter. Any additional instructions for downloading files will be available at the time updates are released.

When an update is available, save the file to a USB flash drive and insert the drive into either USB-A port on the meter. Wait a second after inserting for the meter to recognize the flash drive then select the **CHECK FOR UPDATE** button from the Meter Information screen. If an update is located, an “**Update found...**” message will appear. Click on the **Update** button to load the firmware update.

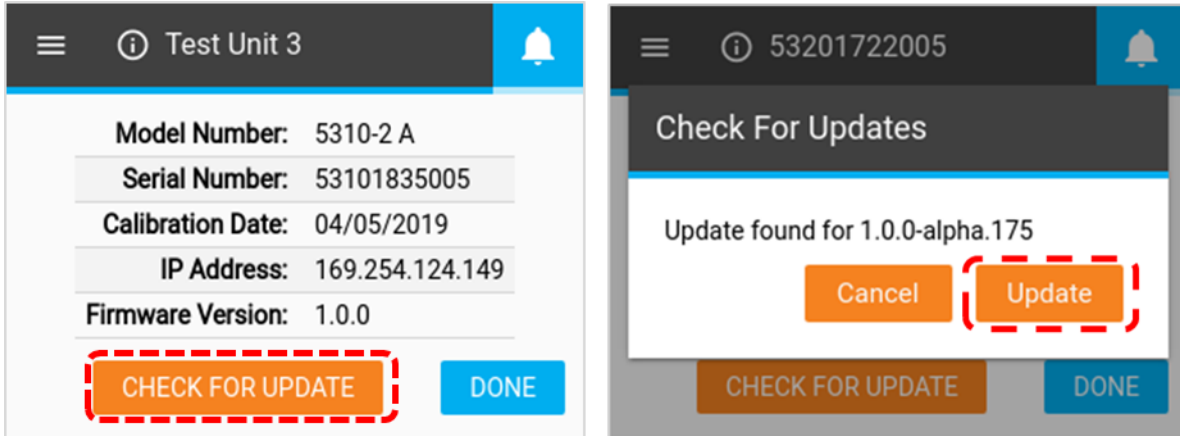

Please allow up to several minutes for the meter to update its firmware. Once complete, an “**Update Successful!**” message will display briefly and the meter will automatically reboot. After reboot the meter will be ready for operation. If the meter does not initialize after the firmware update, an additional instrument reboot may be necessary.

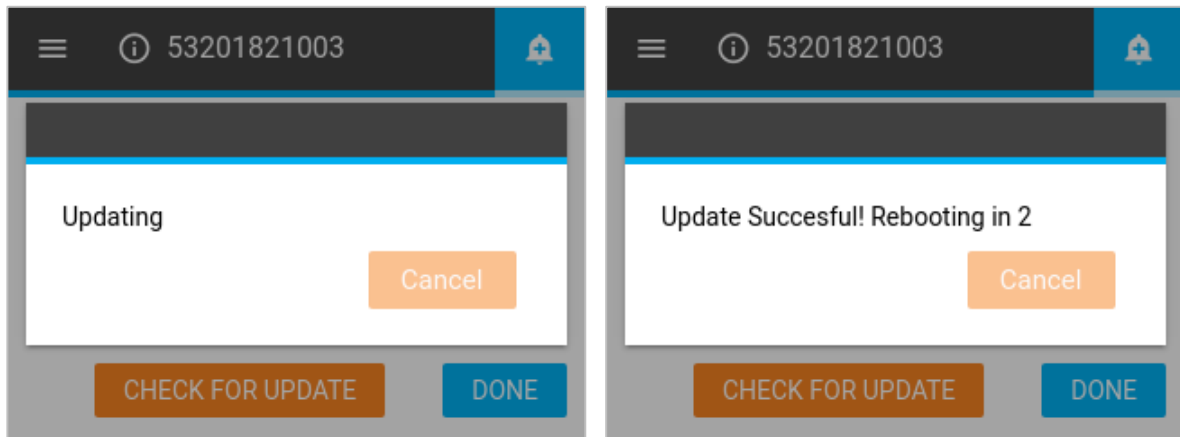

Device Settings

In the Device Settings screen, you can view and edit device settings such as flow control, humidity compensation, display update rate, and gas standard conditions. Open the Device Settings screen by navigating to the Menu Screen and pressing the Gear icon in the header bar. The Device Settings screen is comprised of three tabs: [4040 Mode](#), [Config](#), and [User Gas Std](#).

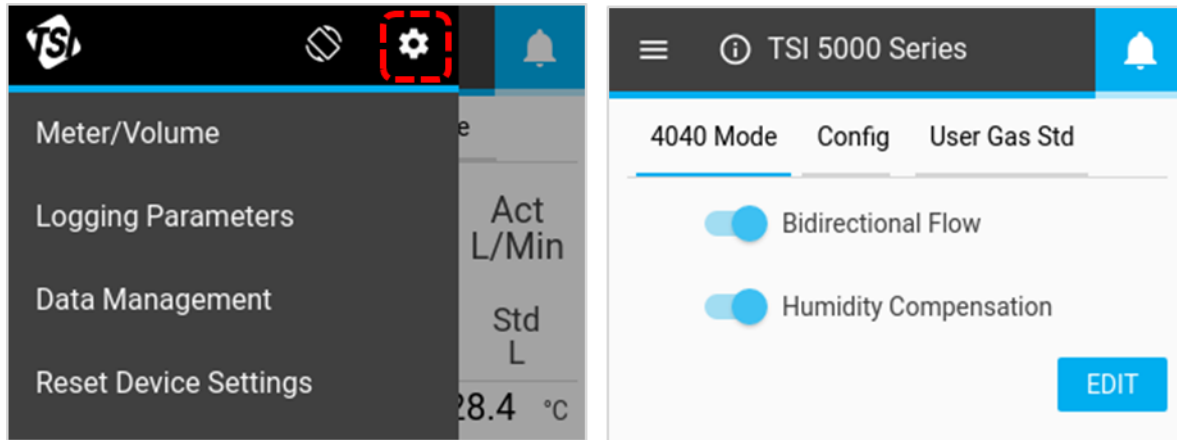

4040 Mode

On the “**4040 Mode**” tab in the Device Settings, you can disable the Bidirectional Flow and Humidity Compensation features, returning the Flow Multi-Meter to a state similar to the 4000 Series flow meter. To disable either of these features, select **EDIT** button and then click on the feature you would like to disable. The button will slide to the left and become disabled. Press the **SAVE** button to save your changes.

Disabling the Bidirectional Flow will result in the Flow Multi-Meter displaying and recording all flows, regardless of their direction, as positive with a left to right → directional indicator.

Models 5320 and 5330 have the option to disable their Humidity Compensation feature. With humidity compensation disabled, the 5300 Series will deliver flow readings irrespective of the water vapor present in the gas flow.

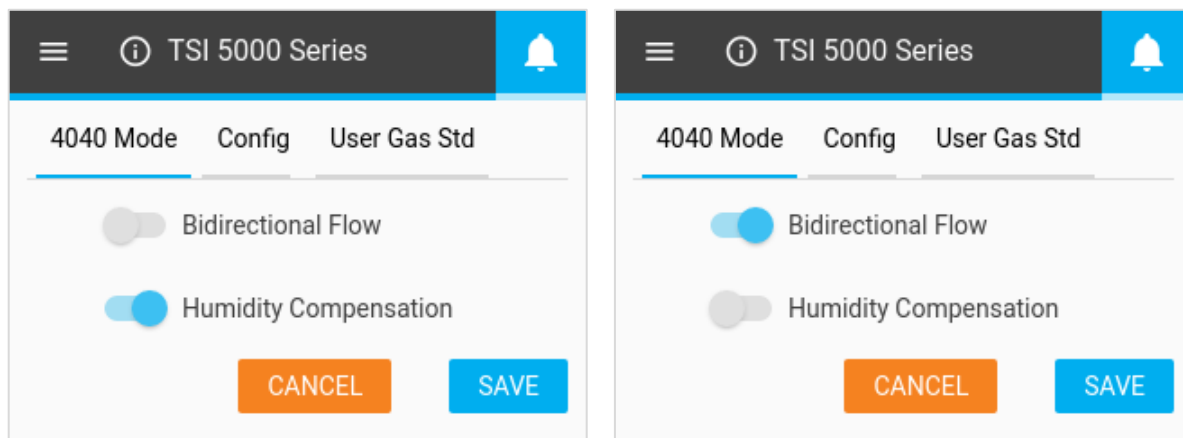

Display Update Rate

The update rate is the rate at which readings are updated on the meter display for all parameters. The default update rate for the 5300 Series Multi-Meter is 0.5 seconds. To change this setting, select from a list of options (0.5, 1, 2, 5, or 10 seconds). Note that you can specify a custom display update rate through FLO-Sight™ PC Software.

To change the update rate, navigate to the **Config** tab in the Device Settings screen, press the **EDIT** button, use the scroll arrows to select a new rate then click **SAVE**.

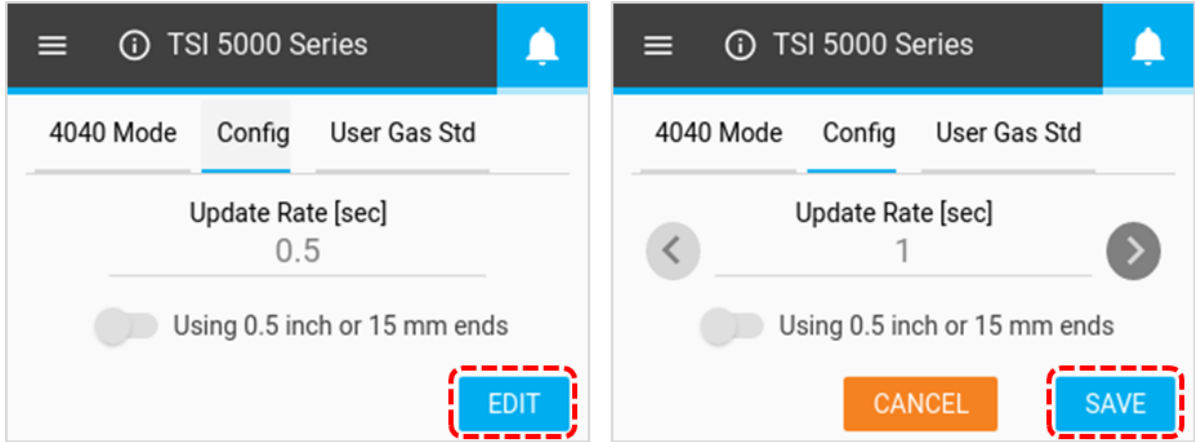

Using 0.5 inch or 15-mm Tube Ends

If the 0.5 inch or 15-mm tube ends are connected directly to the instrument, then TSI® recommends selecting the Tube Ends Toggle Switch in the meter's Settings screen. The 5300 Series will still measure within its published accuracy spec even if this recommendation is not followed, but selecting the toggle switch ensures the most accurate flow measurement readings.

See the section on this topic in [Chapter 2](#) of this manual for more information on when to use the 0.5 inch or 15-mm Tube End toggle switch.

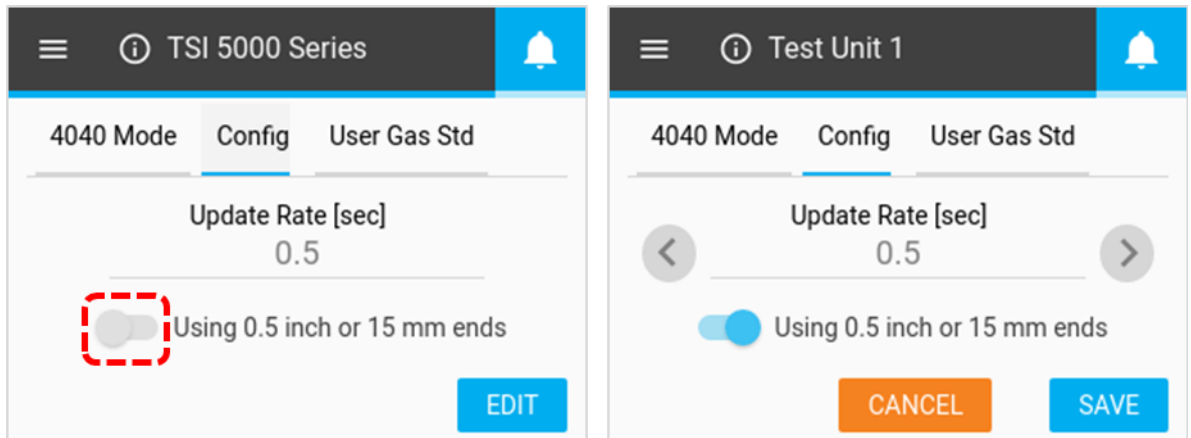

User Gas Standard

The standard temperature and pressure used for gas flow measurements is displayed in the **User Gas Std** tab of the Device Settings. The default standard temperature and pressure is 21.11°C and 101.3 kPa, respectively.

The gas standard conditions can be changed through FLO-Sight™ PC Software only. Any changes made through the software will be reflected on the meter.

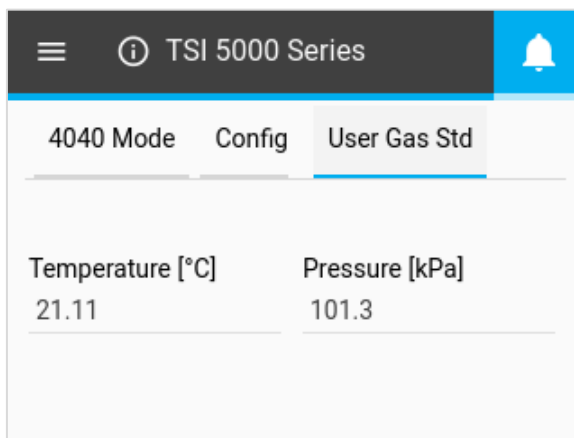

Reset Device Settings

The Reset Device Settings screen is where you can:

- Zero the low differential pressure sensor
- Reset the totalizer counter
- Reset the meter back to factory defaults

Navigate to this screen by opening the Menu and selecting **Reset Device Settings** from the drop-down.

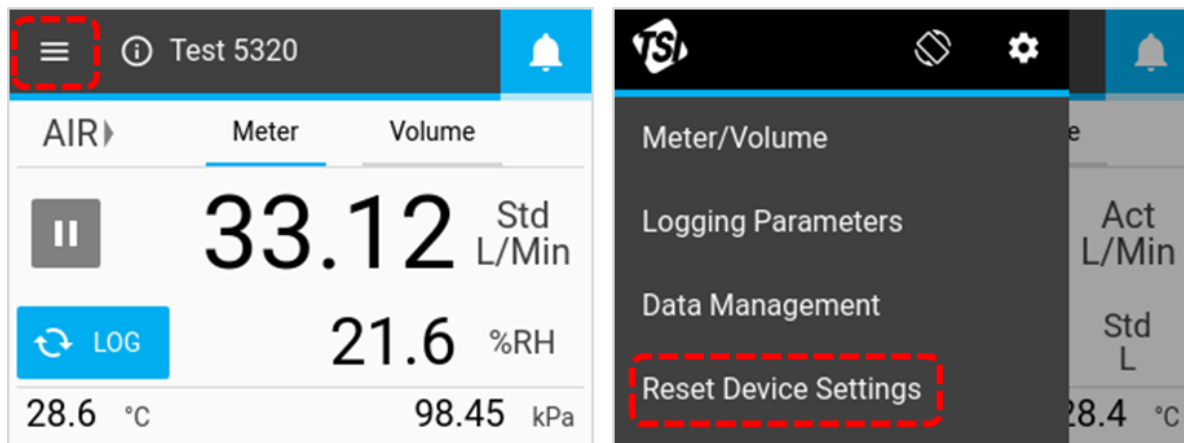

Zero Low Pressure

Models 5310, 5320, and 5330 Gas Flow Multi-Meters have an integrated differential pressure sensor. To zero the differential pressure sensor, click the **Zero** button, then click the **Zero** button again in the **Zero Low Pressure** dialog box.

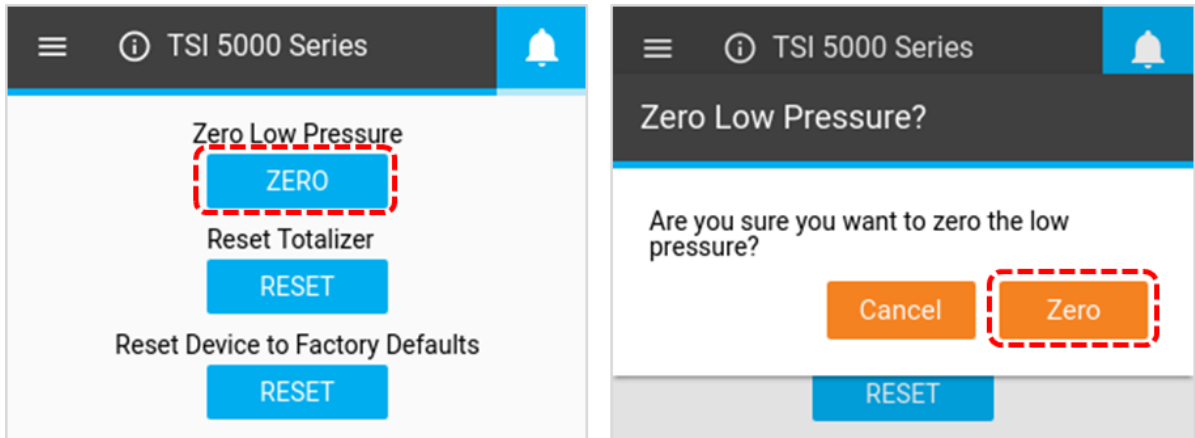

Reset Totalizer

All 5300 Series Gas Flow Multi-Meters include a totalizer feature that measures total volume by integrating flow over time. This is a calculated measurement performed by the meter and operates as a running total. To reset the Totalizer counter to zero, select the middle **RESET** button, then click the Reset button in the Rest Totalizer dialog box.

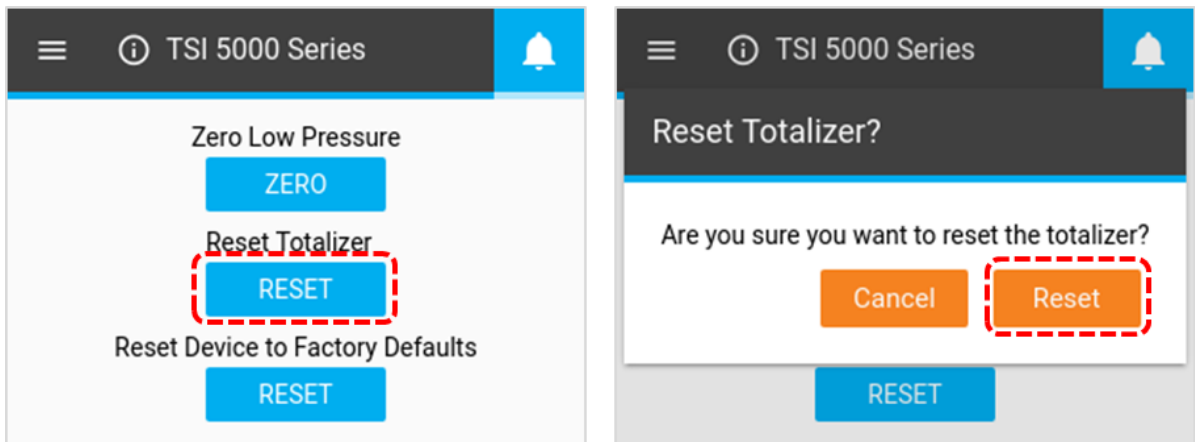

Reset Device to Factory Defaults

The 5300 Series Gas Flow Multi-Meter can be reset to its factory default settings. See the table below for details on the settings which will be affected. Resetting the device to factory defaults will not affect any logged data files stored on the meter. To reset to factory defaults, select the lower **RESET** button, then click **Reset** in the Reset Settings dialog box.

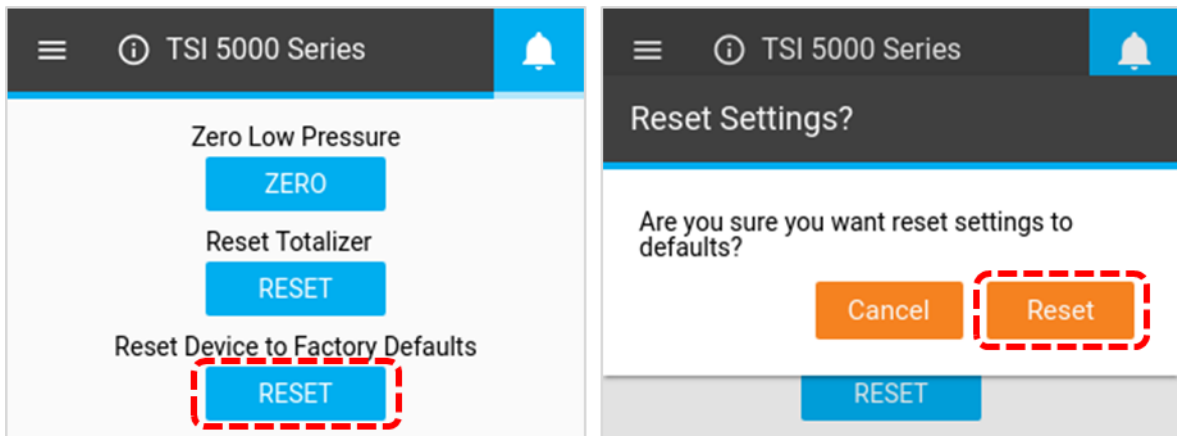

Factory Default Settings

Description	Setting	Default Condition
Measurement Parameters	Flow	Std L/min
	Temperature	°C
	Absolute Pressure	kPa
Gas Calibration	Type of Gas	Air (if available)
Gas Standard Conditions	Temperature	21.11°C
	Absolute Pressure	101.3 kPa
Volume	Sampling Stopped	Std L
	Begin Trigger	1 L, Positive slope
	End Trigger	1 L, Negative slope
	Flow Mode	Flow, Continuous
Logging Parameters	Sample Time	1 millisecond
	Test Length	15 seconds
	Log Name	Log 1
Meter Information	Device Name	"TSI 5000 Series"
Device Settings	Bidirectional Flow	Enabled
	Humidity Compensation	Enabled (if available)
	Update Rate (Display)	0.5 seconds

CHAPTER 5

Maintenance

Flow Sensor

Periodically inspect the flow sensor by looking into the outlet of the flow meter. Remove dust, particles and fibers from the sensor, with clean, dry compressed air. The flow sensor will break if touched.

NOTICE

**NEVER RUN LIQUIDS THROUGH THE FLOW METER AND
NEVER TOUCH THE SENSOR WITH A BRUSH.**

Dust or other deposits on the flow sensor will degrade the 5300 Series Multi-Meter's flow accuracy.



CAUTION

The flow meter must be switched off for cleaning. Only use clean, dry, compressed air when attempting to remove contamination from the sensor.

Re-Certification

To maintain a high degree of confidence in the measurements made by the 5300 Series Gas Flow Multi-Meter, TSI® recommends that the instrument be returned to TSI® every 12 months for re-certification. For a nominal fee, TSI® will recalibrate the unit and return it to you with an As-Found and As-Left Certificate of Calibration with US National Institute of Standards Technology (NIST) traceability. This annual re-certification assures you consistently accurate measurements and is especially important for applications in which strict calibration records must be maintained.

To send your 5300 Series Gas Flow Multi-Meter back to TSI® for re-certification, please visit TSI®'s website at www.tsi.com, select **Register a repair / calibration** under the Support tab, and follow the instructions. If you are having difficulty completing this process, please contact TSI® Incorporated's Customer Support Group for assistance by calling 800-680-1220 or 651-490-2860.

Damaged Tube End Connections

If the tube end connections become damaged, note that the 5300 Series Multi-Meter does not need to come back to TSI® for repair. The damaged tube end connections can be replaced by ordering the appropriate connection size. Reference the list of optional accessories in [Chapter 1](#) of this manual for part number.

Cases

If the instrument case or storage case needs cleaning, wipe it off with a soft cloth dipped in isopropyl alcohol or mild detergent. Never submerge the Multi-Meter or allow liquids to enter the flow tube.

Storage

When storing the Multi-Meter, always cover the ends of flow tubes with the provided end caps to prevent dust or other foreign matter from entering the tube.



CHAPTER 6

Troubleshooting

The table below lists the symptoms, possible causes, and recommended corrective actions for common problems encountered with the Multi-Meter. If the symptom is not listed, or if none of the solutions solve the problem, please contact TSI® Customer Support at 1-800-680-1220 or 651-490-2860.

Symptom	Possible Causes	Corrective Action
No display.	Unit not switched on.	Switch on the unit.
	No power to instrument.	Connect the USB-C to USB-A cable from the USB-C port on the meter to a USB compatible power source that can provide 5 VDC.
When powered through a PC, the meter recycles through boot up process or is unable to complete the initialization.	Computer USB port unable to sufficiently power the meter.	Connect the USB-C to USB-A power cable to the provided USB hub cable, then plug the hub cable into the USB-A port of the computer, and plug the USB-C to USB-A cable into the USB-C port located on top of the meter.
Temperature reads high at low or zero flows.	Temperature sensor is being heated from the flow sensor.	This is normal. Once flow exceeds 1 Std L/min, the temperature will track the flowing gas temperature.
Flow readings fluctuate badly.	The flow is fluctuating.	Improve inlet conditions or increase display averaging time. See the Device Settings section in Chapter 4 of this manual for information on the display update rate.
Display shows flows over-range with no flow passing through flow tube.	The sensor may be damaged or broken.	Return flow meter to TSI® for service.

Technical Contacts

- If you have technical or application questions about this instrument, contact an applications engineer at one of the locations listed below.
- If the Gas Flow Multi-Meter fails, or if you are returning it for service, visit our website at tsi.com/service or contact TSI® at:

TSI Incorporated

500 Cardigan Road
Shoreview, MN 55126 USA

Phone: +1-800-680-1220 (USA) or
+1 (651) 490-2860

E-mail: technical.services@tsi.com

TSI Instruments Ltd.

Stirling Road
Cressex Business Park
High Wycombe, Bucks
HP12 3ST
UNITED KINGDOM

Telephone: +44 (0) 149 4 459200

E-mail: tsiuk@tsi.com

TSI Instruments Singapore Pte Ltd

150 Kampong Ampat
#05-05 KA Centre
Singapore 368324

Telephone: +65 6595-6388

Fax: +65 6595-6399

E-mail: tsi-singapore@tsi.com

TSI GmbH

Neuköllner Strasse 4
52068 Aachen
GERMANY

Telephone: +49 241-52303-0

E-mail: tsigmbh@tsi.com

TSI Instrument (Beijing) Co., Ltd.

Unit 1201, Pan-Pacific Plaza
No. 12 A, Zhongguancun South Avenue
Haidian District, Beijing, 100181
CHINA

Telephone: +86-10-8219 7688

Fax: +86-10-8219 7699

E-mail: tsibeijing@tsi.com

TSI France Inc.

Hotel technologique
BP 100
Technopôle de Château-Gombert
13382 Marseille cedex 13
FRANCE

Telephone: +33 (0)1 41 19 21 99

E-mail: tsifrance@tsi.com

Returning the Gas Flow Multi-Meter for Service

Before returning the Gas Flow Multi-Meter to TSI® for service, visit our website at tsi.com/service or call TSI® at 1-800-680-1220 (USA) or +1 (651) 490-2860 for specific return instructions. Customer Service will need this information when you call:

- The instrument model number
- The instrument serial number
- A purchase order number (unless under warranty)
- A billing address
- A shipping address.

TSI® recommends that you keep the original packaging (carton and foam inserts) of the Gas Flow Multi-Meter for use whenever the Gas Flow Multi-Meter is shipped, including when it is returned to TSI® for service.

CHAPTER 7

FLO-Sight™ PC Software

All 5300 Series Gas Flow Multi-Meters come with FLO-Sight™ PC Software, FLO-Sight™ PC Software allows you to fully control and operate their 5300 Series meters directly from your computer. Using the meter through FLO-Sight™ PC Software also enables additional functionality and configuration options not available from the meter itself.

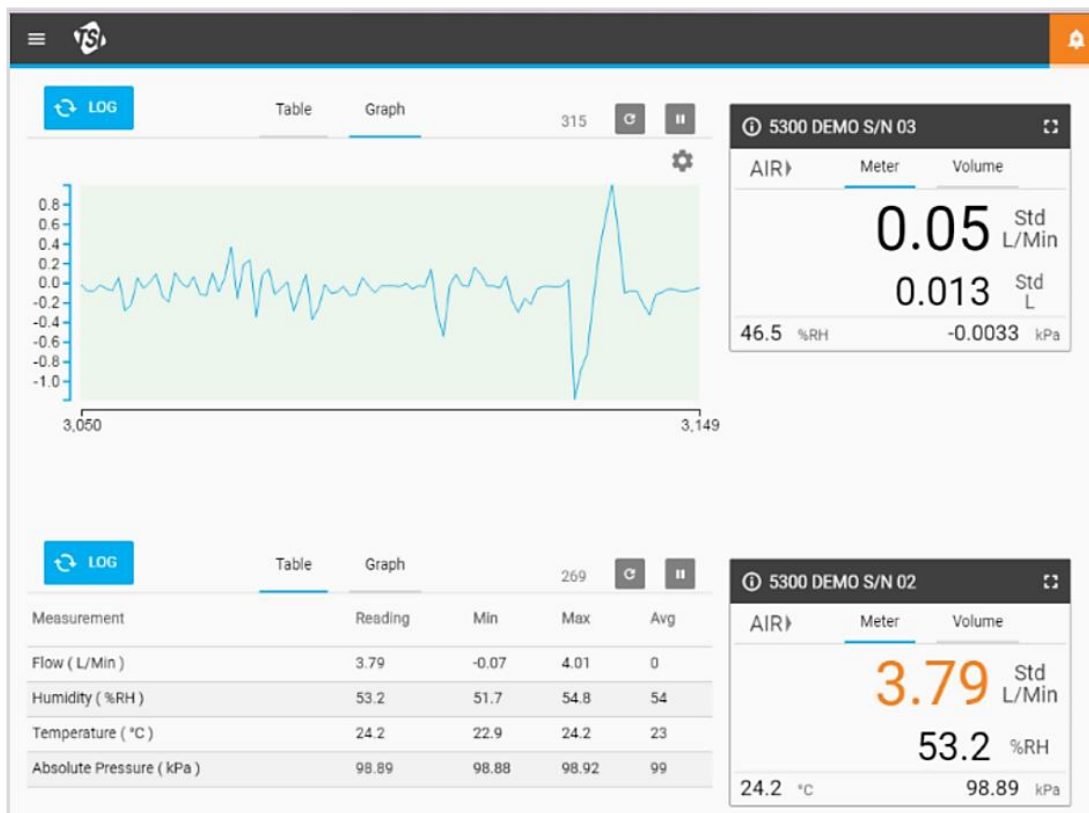

FLO-Sight™ software has these basic features:

- Real-time display of all measurement parameters
- Min, max, and average readings
- Advanced meter configuration

FLO-Sight™ software advanced features include:

- Real-time graphing
- Data logging, download, and file management
- Alerts set for any parameter
- Multiple meter operation

There are two versions of FLO-Sight™ PC Software: Basic and Advanced. The Basic version is available to all 5300 Series users and can be downloaded from [TSI.com](https://www.tsi.com). The Advanced version has additional features and can be purchased through the software itself or from [TSI.com](https://www.tsi.com). A free trial of the advanced version is included with the purchase of a 5300 Series Flow Multi-Meter.

Please refer to the *FLO-Sight™ PC Software Manual* for more information on downloading, installing, and operating FLO-Sight™ PC Software.

(This page intentionally left blank)

CHAPTER 8

Serial Command Set

The 5000 Series can establish communication with a computer over either a direct USB link utilizing a NDIS driver or over RS-232 utilizing a USB to RS-232 converter. Once the meter has been connected, you can communicate via serial using ASCII commands.

The ASCII commands are case sensitive. Upper case letters are used throughout the command set except as designated. Each command sent to the flow meter must be terminated by a carriage return (CR = 0x0d). Line feeds (LF = 0x0a) are ignored.

Listed below is a summary of the commands. For more details, please refer to the *5000 Series ASCII Command Set Manual*.

Commands for Flow Rate, Temperature, Pressure, and Volume

Command	Description	Backward Compatible with 4000/4100 Series
DmFTPnnnn	Returns flow rate, temperature, and absolute pressure data at an interval equal to the sample rate.	Yes
DmFTPnHLInnnn	Returns flow rate, temperature, absolute pressure, humidity, low pressure and totalizer data at an interval equal to the sample rate.	No
Vmnnnn	Returns a volume measurement by integrating flow rate over time.	Yes

Measurement Setup Commands

Command	Description	Backward Compatible with 4000/4100 Series
SBTx\pmnnn.nn	Sets the begin-trigger level for starting data acquisition.	Yes
SETx\pmnnn.nn	Sets the end-trigger level for stopping data acquisition.	Yes
CBT	Clears the begin-trigger level.	Yes
CET	Clears the end-trigger level.	Yes
SSRnnnn	Sets the sample rate at which the data is returned.	Yes
SGn	Sets the gas calibration to be used.	Yes
SGMmm	Selects the air/oxygen mixture concentration.	Yes
SUn	Selects either standard or volumetric units of flow.	Yes
SSTnn.nn	Sets user standard temperature.	Yes
SSPnnn.nn	Sets user standard pressure.	Yes

Command	Description	Backward Compatible with 4000/4100 Series
SDU2	Sets output flow units to Cubic Feet per Minute.	Yes
LPZ	Low pressure zero.	No
SCHx	Turn humidity correction off.	No
SCDx	Turn bi-directional sensor off.	No

Miscellaneous Commands

Command	Description	Backward Compatible with 4000/4100 Series
Rxx	Reads the current values of the changeable operating parameters.	Yes
DEFAULT	Restores the values of changeable operating parameters to factory default settings.	Yes
SN	Returns the serial number of the flow meter.	Yes
MN	Returns the model number of the flow meter.	Yes
REV	Returns the internal firmware revision of the flow meter.	Yes
HREV	Returns the internal hardware revision of the flow meter.	No
DATE	Returns the date of the last calibration.	Yes
?	Returns "OK" to tell if the flow meter is communicating.	Yes
SUSTRxxxxxxxx	Set user string.	Yes
RUSTR	Read user string.	Yes
SALIASxxxxxxx xxxxxxxxxxx	Set meter alias.	No
RALIAS	Read user string.	No
BREAK	Stop the current sending of data.	No
SBAUDnnnnnn	Set RS-232 baud rate.	No
RBAUD	Read RS-232 baud rate.	No

Display Commands

Command	Description	Backward Compatible with 4000/4100 Series
SURnnnn	Sets the update rate for the LCD display.	Yes

APPENDIX A

5300 Series Flow Multi-Meter Specifications

Measurement Specifications*		
Flow Measurement	Gas Calibrations	Air, O ₂ , CO ₂ , N ₂ , (user selectable)
	Range	0 to ±300 Std. L/min 0 to ±100 Std L/min (CO ₂)
	Accuracy <i>See notes 1 through 6 below</i>	Models 5300, 5310, 5320 2% of reading or 0.05 std. L/min, whichever is greater Model 5330 1.7% of reading or 0.05 slpm for forward flows, 2% of reading or 0.05 std. L/min for reverse flows Model 5303 3% of reading or 0.1 std. L/min, whichever is greater
	Response	4 ms to 63% of full scale
	Units	L/min or ft ³ /min (Standard, Volumetric, Actual, or Remote)
Temperature Measurement	Range	-10 to 50°C
	Accuracy	±1°C at flows > 1 Std. L/min in the forward direction
	Response	<= 75 ms to 63% of final value for step change
	Units	°C, °F
Absolute Pressure Measurement	Range	50 to 200 kPa
	Accuracy	±1 kPa
	Response	<= 4 ms to 63% of final value for step change
	Units	Pa, hPa, kPa, mbar, PSI, mmHG, cmH ₂ O, inH ₂ O
Low Differential / Breathing Circuit Pressure Measurement	Range	±150 cmH ₂ O
	Accuracy	±0.5% of reading or 0.15 cmH ₂ O, whichever is greater
	Response	<= 4 ms to 63% of final value for step change
	Units	Pa, hPa, kPa, mbar, PSI, mmHG, cmH ₂ O, inH ₂ O
Humidity Measurement	Range	10-90% RH, -10 °C to +19 °C Dew Point
	Accuracy	±3% of reading
	Response	<= 3 seconds to 63% of final value for step change
	Units	% RH, Dew Point (°C, °F)
Volume Measurement	Range	0.004 to 99 L
	Accuracy	2% of reading or 1 mL whichever is greater, at peak flows greater than 2.5 std. L/min <i>See notes 1 through 6 below</i>
	Units	L, mL, ft ³

Measurement Specifications*		
Totalizer Measurement	Range	0.05 to 400,000 L
	Accuracy	±4% of reading
	Units	L, mL, ft ³
Burst Pressure	Tested to 690 kPa without rupture. DO NOT exceed 690 kPa.	
Pressure Drop	See Chart Below	
Instrument Temperature Range	Operation	-10 to 50°C (ambient)
	Storage	-20 to 70°C (ambient)
Instrument Pressure Range	Operation	50 to 200 kPa
Power	Supplied through USB-C port	
	5.0 VDC ±5%, 500 mA maximum	
Digital Output	USB, RS-232 Serial using USB to RS-232 converter cable	
Display	2.8-inch Color LCD Touchscreen	
Internal Storage	1 GB storage, max 20 datalog files	
Physical Dimensions	External	See Diagram Below
	Weight	230 grams including protective end caps
	Material	Polycarbonate (Flow body)

NOTES:

- 1 Flow accuracy stated between 15 and 25 °C and 101.3 kPa.
 - Add an additional 0.085% of reading per 1°C away from the base operating range of 15 to 25 °C.
 - Add an additional 0.01% of reading per 1 kPa above 101.3 kPa *or*
 - Add an additional 0.02% of reading per 1 kPa below 101.3 kPa when operating within the pressure range of 70 kPa to 170 kPa.
- 2 Flow accuracy stated with gas temperature and flow body temperature within ±10°C of one another.
- 3 Flow accuracy stated measuring dry gas (less than 10% R.H.). Add an additional ±1.0% of reading per 10% of RH away from 0% for models without humidity compensation.
- 4 Abrupt changes from high to low reverse flow may require additional stabilization time to achieve full accuracy. Please contact TSI® for more information.
- 5 Includes ±0.5% of reading repeatability.
- 6 Volumetric flow rate is calculated from the mass flow measurement. Add an additional 0.25% of reading to the flow accuracy to account for the uncertainty in measuring gas temperature and pressure.

*Specifications subject to change without notice.

5300 Series Pressure Drop

cmH2O Pressure Drop

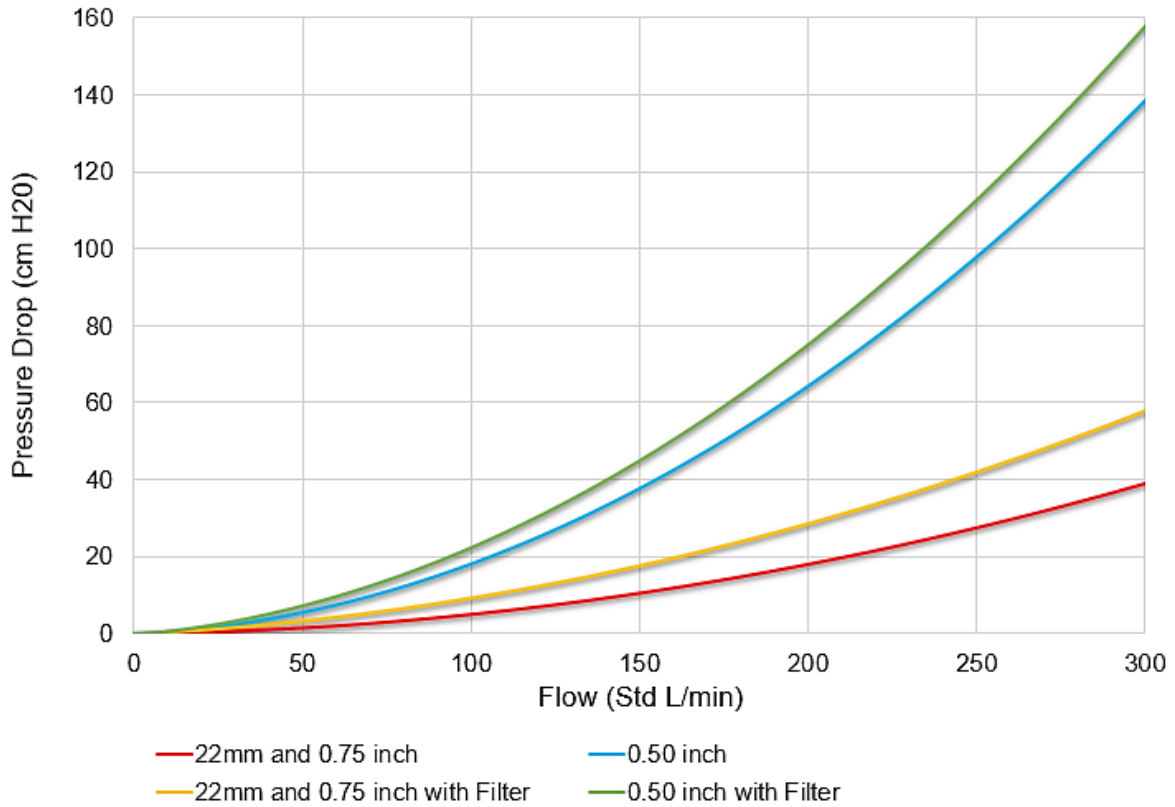

mBar Pressure Drop

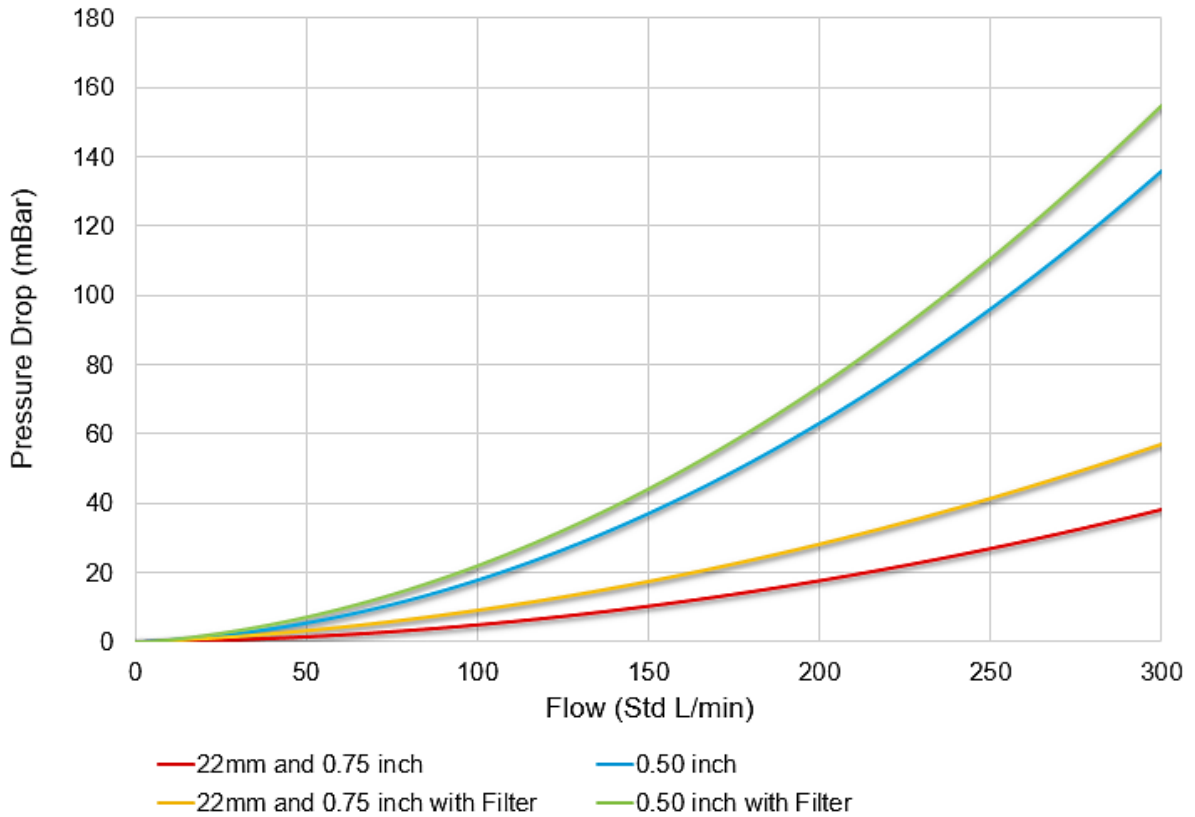

5300 Series Dimensions

Dimensions are in inches [mm]

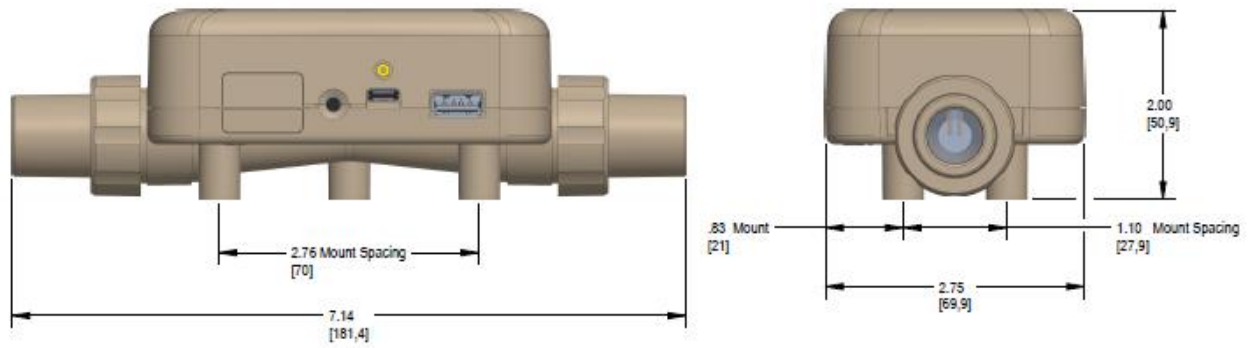

Mounting threads: M3

APPENDIX B

Standard Flow Rate vs. Volumetric Flow Rate

Since thermal flow sensors are sensitive to changes in air density and air velocity, all thermal flow meters indicate flow rates with reference to a set of standard conditions. For TSI® instruments, standard conditions are defined as 21.1°C (70°F) and 101.3 kPa (14.7 psia). Other manufacturers may use different values.

Standard flow rate is the equivalent flow rate the gas would be moving at if the temperature and pressure were at standard conditions. It is usually the most useful measure of gas flow because it defines the mass flow, number of molecules, and heat-carrying capacity of the gas.

Volumetric flow rate is the actual volume flow of the gas exiting the Flow Meter.

In some instances, volumetric flow rate rather than standard flow rate may be of interest. To display the volumetric flow rate, the 5000 Series Multi-Meter will multiply the standard flow measurement by the following density correction factor:

$$\text{Volumetric Flow} = Q * \left(\frac{T_m}{T_{std}} \right) \left(\frac{P_{std}}{P_m} \right)$$

Where:

Q = Standard flow rate

T_m = Gas temperature measured in flow tube in units of degrees Celsius

P_m = Absolute pressure measured in flow tube in units of kPa

TSI® Flow Meters use $T_{std} = 21.11^\circ\text{C}$ and $P_{std} = 101.3 \text{ kPa}$ absolute

Example:

The mass flow rate measured by the TSI® Multi-Meter is 100 Std. L/min at 15°C and 117 kPa. The Multi-Meter calculates and displays the volumetric flow as follows.

$$\text{Volumetric Flow} = (100 \text{ std L/min}) \left(\frac{273.15 + 15^\circ\text{C}}{273.15 + 21.11^\circ\text{C}} \right) \left(\frac{101.3 \text{ kPa}}{117.0 \text{ kPa}} \right) = 84.78 \text{ L/min}$$

(This page intentionally left blank)

APPENDIX C

Humidity Compensation

TSI® models 5320 and 5330 can correct their flow measurement in the presence of moist air. Previous models of TSI® flow meters read up to 5% higher in moist air than in dry air. The change in flow reading was due partly from the added mass of water vapor and partly from the change in thermophysical gas properties introduced by mixing water vapor in air.

The 5320 and 5330 model flow meters use a humidity sensor to remove the effect of humidity on the flow measurement. With humidity compensation turned on, the meter will indicate the flow in terms of dry air. In other words, the flow measurement will display the amount of air flow minus the water vapor present.

NOTICE

Humidity compensation is only available when measuring the flow of air.

Disable / Enable Humidity Compensation

Users have the option to disable the humidity compensation feature on their Flow Multi-Meter. With humidity compensation disabled, the meter will deliver flow readings irrespective of the water vapor present in the gas flow. The humidity compensation feature is set to enabled as the default.

To disable humidity compensation, select the Gear icon from the Menu header bar. On the 4040 Mode tab, select **EDIT**, click the Humidity Compensation toggle switch, and **SAVE**. Select the toggle switch again to enable the feature.

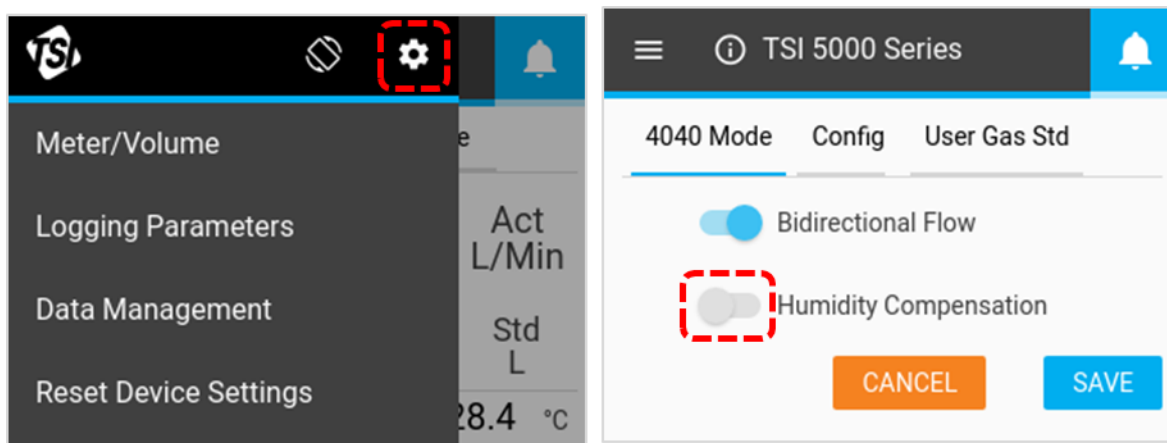

Humidity compensation has also be disabled / enabled through FLO-Sight™ PC Software.

(This page intentionally left blank)

Remote Flow

Theory of Operation

When combined with absolute pressure, low pressure readings can be used to calculate a volume flow rate at a remote point in the system. When set to remote flow measurement, the low pressure value is added to the absolute pressure measured in the channel of the instrument to convert the mass flow of gas at the instrument to volumetric flow at the remote location. The tubing should be connected from the positive (+) port on the instrument tap at the remote location.

NOTICE

The remote flow measurement assumes that the gas temperature is consistent between the two measurement locations. If the gas temperature between the measurement locations is significantly different, the remote flow measurement will no longer deliver a true reading.

Remote Flow Setup

The setup below shows air flowing through two 5000 Series meters in a line. Meter #1 is measuring upstream of the valve and meter #2 is measuring downstream of the valve. Both meters are measuring volumetric flow using the actual temperature and pressure of the air flow.

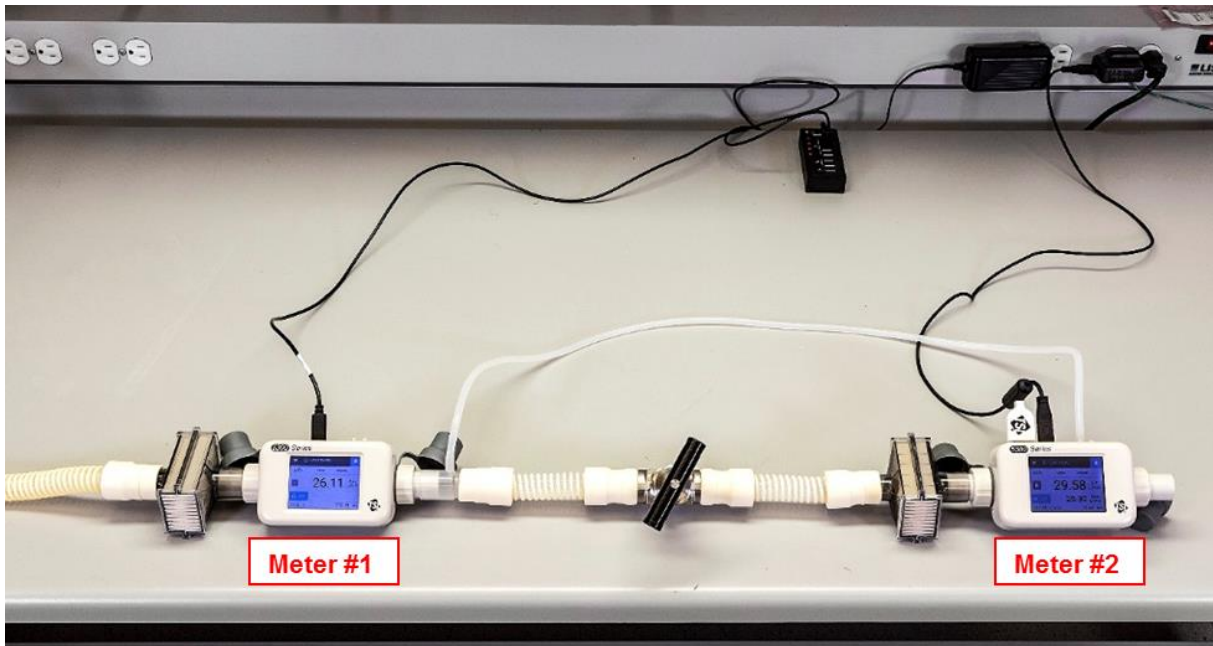

With similar temperature and pressure conditions, the volumetric flow rate between the two measurement points is consistent.

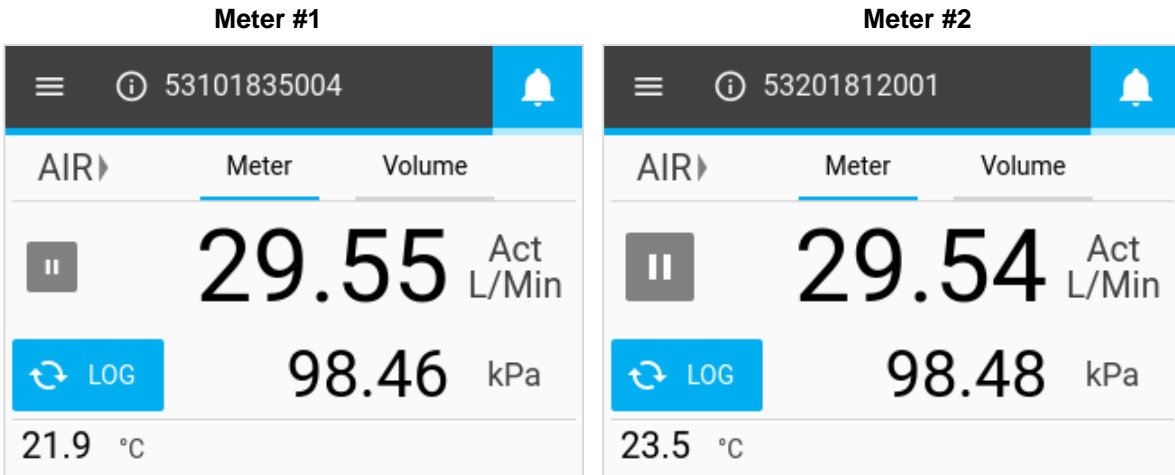

Back pressure is introduced upstream of the valve. The increased pressure of air being measured by Meter #1 causes the volumetric flow reading to decrease. Meter #2 does not experience an increase in pressure and its flow reading remains steady. The remote flow measurement is taken upstream of the valve and is consistent with the volumetric flow reading from Meter #1 at the same location in the line.

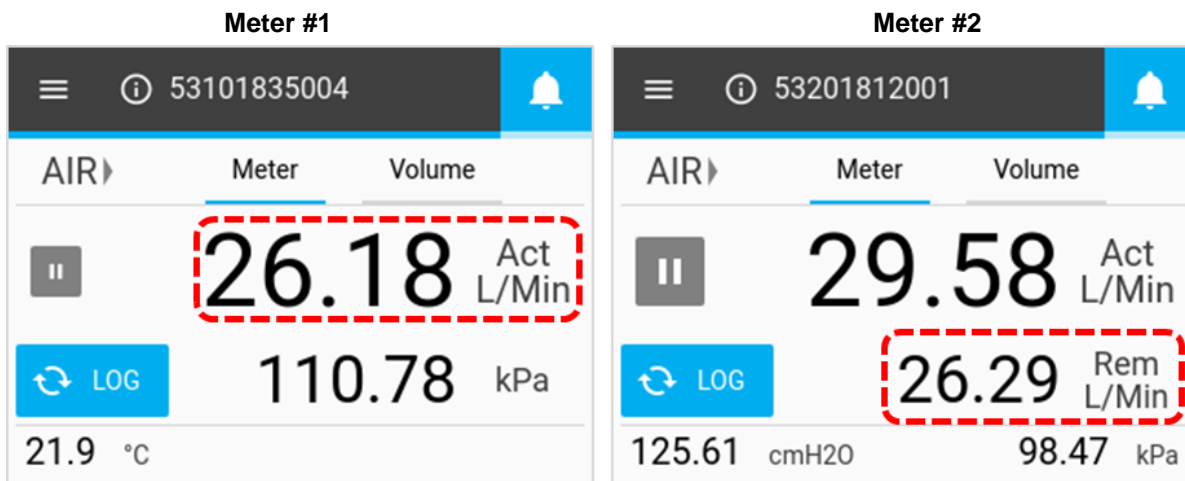



Knowledge Beyond Measure.

TSI Incorporated – Visit our website www.tsi.com for more information.

USA	Tel: +1 800 680-1220	India	Tel: +91 80 67877200
UK	Tel: +44 149 4 459200	China	Tel: +86 10 8219 7688
France	Tel: +33 1 41 19 21 99	Singapore	Tel: +65 6595 6388
Germany	Tel: +49 241 523030		

P/N 6011689 Rev G

©2023 TSI Incorporated

Printed in U.S.A.

