

INSTALLING PM10/PM2.5/PM1.0 IMPACTOR ONTO THE OMNIDIRECTIONAL INLET MODEL 854040

QUICK START GUIDE

P/N 6008674, REVISION A
MAY 2015







TSI and TSI logo are registered trademarks of TSI Incorporated.



This guide will help you quickly install the PM10, PM2.5, and PM1.0 Impactor Kits (854020/854021/854022) for Omni directional Inlet (854040).

Unpacking the Impactor Kit (854020/854021/854022) for Omni Directional Inlet (854040).

1. Unpack the Impactor Kit for Omni directional Inlet (854040) and verify that all the items listed in the following table are present.
2. Contact [TSI](#) immediately if items are missing or broken.

Qty.	Item Description	Reference Picture
1	Impactor Housing	
2	O-Ring	
1	Impactor Kit will contain one of three different impactors: 854020 PM10 854021 PM2.5 854022 PM1	
1	Impactor Oil	

Installing the PM10/PM2.5/PM1.0 Impactors (854020/854021/854022)

1. Unscrew the water trap and Omnidirectional Inlet (854040) to separate it from its base. The interface between the sections can be easily identified by the knurled interface.

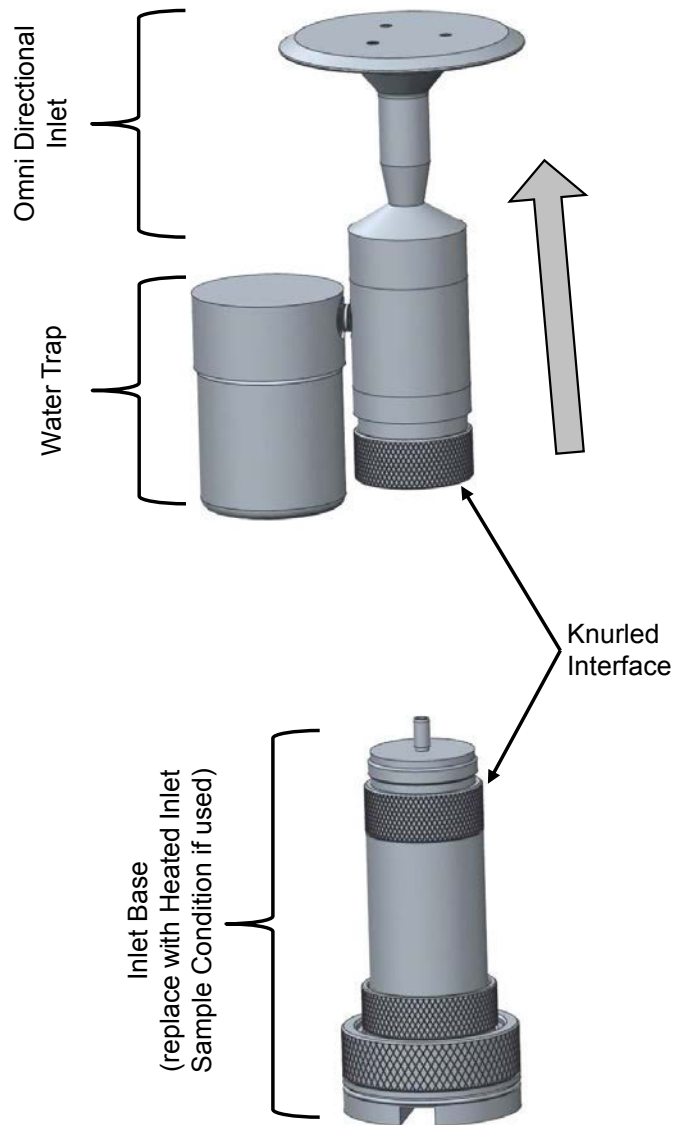

2. Apply 2 drops of oil (included) to the impactor plate.

Do not over-fill impaction plate.



- Screw (hand-tighten) impactor back together.



- Install the Impactor onto the Inlet Base (or Heated Inlet Sample Conditioner if used).

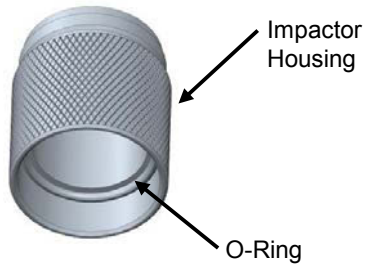

- Ensure the O-ring included with the Impactor Kit is installed into the bottom of the Impactor housing.

- Thread the Impactor housing with O-ring onto the Omni directional Inlet base.



- Re-attach water trap and Omni-directional Inlet Impactor Housing.

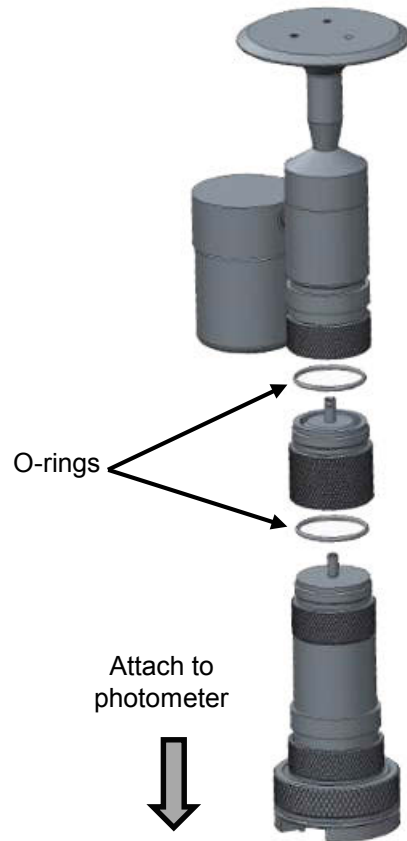

- Attach column to Photometer inside Enclosure.

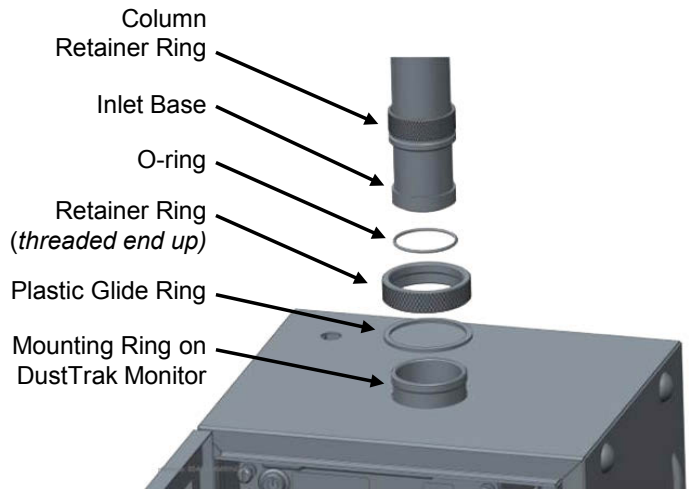

Cleaning and Oiling Impactors

Impactors need periodic cleaning and maintenance to ensure good performance. The maintenance interval is dependent on the aerosol concentration and sampling run time. The impactors should be cleaned and oiled prior to every use and when accumulated aerosol is evident on the impactor plate.

- 1 Unscrew Impactor. Check O-ring on the impactor base.
- 2 Clean outside and inside of Impactor and the impactor plate using a clean brush and a light solvent. Dry impactor parts by blowing it out with compressed air, or let it air-dry thoroughly.

- 3 Apply 2 drops of oil (included) to the impactor plate.

Do not over-fill impaction plate.

- 4 Screw (hand-tighten) impactor back together.



Maintenance Intervals

To keep impactor performing with proper cut point, clean and re-oil impaction plate at the following intervals

Average dust concentration (mg/m ³)	Impactor maintenance interval
0.035	42 days
0.050	30 days
0.100	16 days
0.150	10 days
0.250	6 days
0.400	4 days



UNDERSTANDING, ACCELERATED

TSI Incorporated – Visit our website www.tsi.com for more information.

USA Tel: +1 800 874 2811 India Tel: +91 80 67877200
UK Tel: +44 149 4 459200 China Tel: +86 10 8219 7688
France Tel: +33 1 41 19 21 99 Singapore Tel: +65 6595 6388
Germany Tel: +49 241 523030