

ALNOR® HVAC ASSESSMENT HANDBOOK

A PRACTICAL GUIDE TO PERFORMANCE
MEASUREMENTS IN MECHANICAL HEATING,
VENTILATING, AND AIR CONDITIONING SYSTEMS

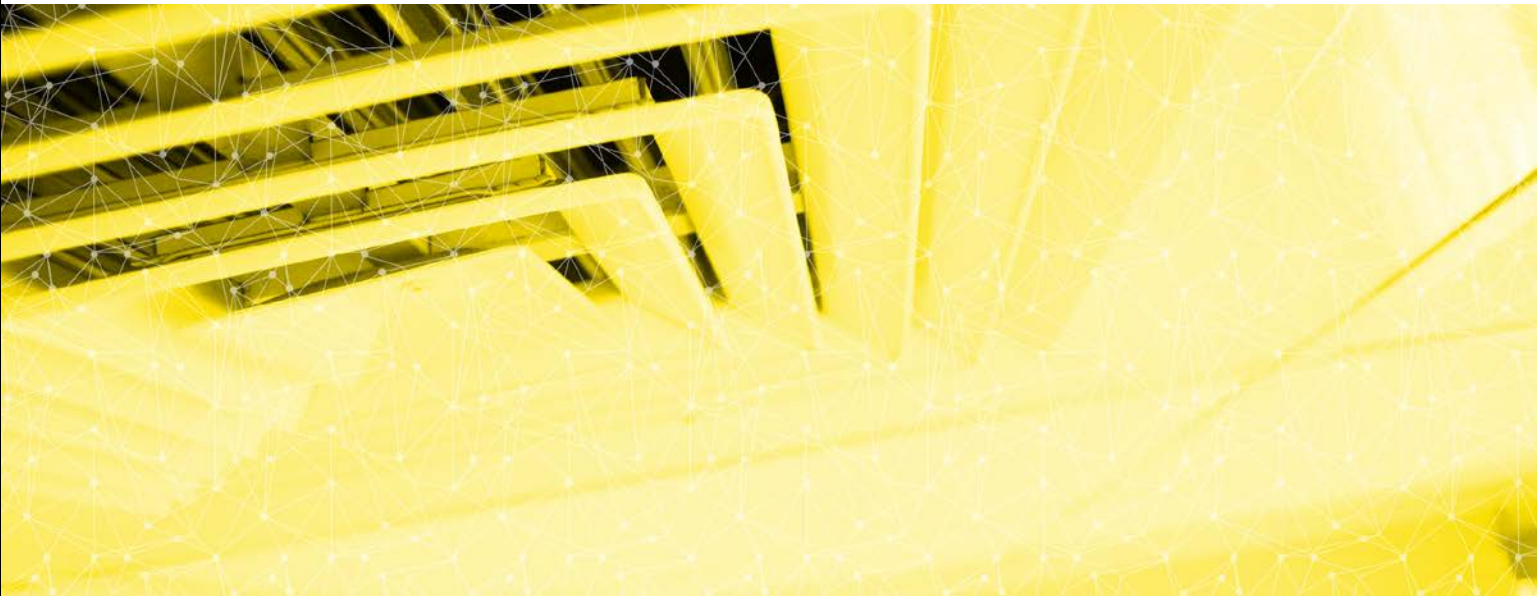

ALNOR® HVAC HANDBOOK

A PRACTICAL GUIDE TO PERFORMANCE
MEASUREMENTS IN MECHANICAL HEATING,
VENTILATING AND AIR CONDITIONING SYSTEMS

CONTENTS

INTRODUCTION	1
General.....	1
HVAC Systems, Comfort, and Energy Management	1
TAB: Testing, Adjusting, and Balancing.....	2
Certification and Clean-air Measurements	3
IAQ	3
MEASUREMENT INSTRUMENTATION	4
Capture Hoods	4
Mechanical (Analog) Capture Hoods	4
Digital Capture Hoods	5
Digital Capture Hoods with Differential Pressure Sensor	6
Thermo-Anemometers (Hot-Wires).....	6
Basic Thermo-Anemometers.....	7
Thermo-Anemometers with Mathematical Calculations	7
Comprehensive Thermo-Anemometers.....	7
Rotating Vane Anemometers	8
Mechanical Rotating Vanes	8
Digital Rotating Vanes	8
Deflecting Vane (Swinging Vane) Anemometers	9
Velometer Jr	9
Manometers	10
Digital Micromanometer	10
Digital Auto-Zeroing Micromanometer	11
Pitot Tube.....	12
Hydronics.....	13
Mechanical Gauges.....	13
Digital Hydronic Manometers.....	14
IAQ: Ventilation and Carbon Dioxide.....	14
Continuous Emission Monitors.....	14
MEASUREMENT BASICS	15
HVAC System Performance.....	15
Measuring Air Velocity and Air Volume at Supply Grilles/Diffusers.....	15
Nonuniform Flow Corrections.....	16
Static Pressure Measurement	17
Exhaust Grille Measurements	17
Duct Traversing: Low to High Velocities and at High Air Temperatures	18
Measuring Air Velocity in Open Areas	19
Testing and Certification.....	19
Differential Pressure Measurement Between Two Rooms or Areas.....	19
Spray Booths.....	20
Laboratory Hoods	20
Unit Ventilators	21
Measuring Slot Velocities.....	21
Clean Room Testing and Certification.....	22
Thermal Comfort and IAQ.....	22
Air Temperature Measurement	22
Relative Humidity Measurement.....	23
CO ₂ Measurements.....	23

APPENDIXES	24
Appendix A—Performing a Duct Traverse	24
Where to Take the Measurement	24
Traversing a Round Duct.....	24
Traversing a Square Duct.....	26
Appendix B—Capture Hood Flow Resistance.....	28
Appendix C—Characterizing a Capture Hood to an Outlet Using a Correction Factor.....	29
Appendix D—Determining the Percentage of Outside Air Using Either Temperature or CO ₂ Measurements	31
Appendix E—Air Changes per Hour (ACH).....	33
Appendix F—Thermal Comfort: Temperature and Humidity.....	34
Appendix G—Density Correction	35
Density Correction for Thermo-Anemometers	35
Density Correction for Pressure Based Manometers or Deflecting Vane Anemometers	35
Appendix H—Useful Calculations	38
Total Pressure Formula	38
Converting Velocity Pressure to fpm	38
Air Flow Formulas	38
Area Formulas	38
Subtracting Obstructions From Area	39
Hydronic Equations	39
Appendix I—Common HVAC Blueprint Symbols.....	40
Appendix J—Typical HVAC System Showing Some Measurement Locations	41
GLOSSARY	42
REFERENCES	44
NOTES	45

INTRODUCTION

General

This handbook has been developed as a tool to assist you in the field and also as a training aid for newer technicians. The contents cover a wide variety of heating and air conditioning ventilation measurement applications and technologies.

Air measurements are a critical concern for a wide range of applications. Facility Managers have long recognized the value of air readings in ensuring the balance, efficiency, and cost effectiveness of a facility's heating, cooling, and ventilation systems. Air flow, temperature, and humidity affect occupant comfort, productivity, and physical health in hospitals, schools, commercial, and industrial facilities. Indoor Air Quality (IAQ) and thermal comfort have become increasingly important in promoting healthy and comfortable work environments in today's workplace.

HVAC Systems, Comfort, and Energy Management

Energy management is central to all building functions. HVAC systems typically account for over one-third of a facility's energy consumption, so it is imperative to properly manage the operation of HVAC systems to ensure economical operation while providing a comfortable, safe environment for occupants.

One group of tools widely recommended for HVAC system performance testing, verification, and energy audits are test and balance instrumentation. These tools are designed to measure air velocity, air volume, temperature, humidity, CO₂, and noise level from heating and air conditioning ventilation ducts to identify problems with airflows, outside air mixing, system balancing, indoor air quality, and occupant comfort. Test instruments provide a means to properly measure and document key HVAC parameters by identifying potential energy conservation measures that can significantly reduce facility energy expenditures.

Measurement tools will help assess the operating efficiencies and discover system problems such as clogged filters, dirty coils, inoperative dampers, improperly programmed building control system loops, excessive outside air, defective thermostats and sensors, and simultaneous heating and cooling—all of which contribute to inefficient HVAC system operation, wasting considerable money. Information from testing is used in building and HVAC system commissioning reports, used to benchmark system performance, and to identify areas of energy waste.

Today's HVAC systems must be energy efficient, satisfy stringent indoor air quality and comfort expectations, and still be designed/constructed within tight budgets. System designs meeting these demands have many components, sub-systems, and controls. Building construction involves many specialized trades that often work independently of one another which can produce HVAC systems that may not perform properly. Without measurement and verification of the optimum operation of systems, performance will fall far short of design specifications, increasing building operating costs needlessly while wasting energy.

Alnor products are ideal for commissioning projects since they are portable and have datalogging capabilities, making it easy to document system performance on a regular basis. Alnor test instruments are available for many different measurement applications and are designed to save money and minimize testing time. These tools can quickly pay for themselves when properly used to measure, diagnose, and correct building HVAC system performance. In addition, these tools can be used to periodically spot-check systems to confirm efficient and economical operation as part of a building-wide, systematic, preventative maintenance program.

TAB: Testing, Adjusting, and Balancing

Testing, adjusting, and balancing (TAB) are specific steps and processes that typically consist of setting volumes (flow), temperatures, pressures, velocities (speed); recording data; making tests; and preparing reports. These activities are performed on building environmental systems including, but not limited to, air distribution systems, hydronic distribution systems, and the equipment and apparatus interconnected to these systems.

All test instruments used for measurement must be accurate and calibration histories for each instrument must be available for examination. Calibration and maintenance of all instruments must be in accordance with the requirements of the applicable TAB certification agency affiliated with the TAB firm performing the work.

Testing—the use of dedicated instruments to measure rotational speed, temperature, pressure, noise level, velocity, and volumetric flow rates to evaluate mechanical equipment and system performance.

Adjusting—the final set point of control or balancing devices such as dampers, valves, thermostats, pressure controllers, pumps, and computer controls.

Balancing—the regulation of air or water system flows through the use of acceptable industry procedures to achieve the designed flow in cubic feet per minute (cfm), gallons per minute (gpm), and air changes per hour (ACH).

HVAC systems initially installed in a building will usually not function at design specifications automatically upon startup. Adjusting a system to function at design conditions requires testing, adjusting and balancing of control devices. Testing, adjusting, and balancing (TAB) is the method used to calibrate the environmental settings within the building. Some of the main goals of TAB include the following:

- Satisfying the occupants' comfort.
- Achieving the conditions of the HVAC system design specifications.
- Extending maintenance intervals and equipment life.
- Meeting energy conservation requirements.
- Operating in an efficient and economical manner.

Many existing buildings have experienced some type of change from their original design. Examples include renovation work, new construction, and activities which may be drastically different from the original intended usage. In these cases, new testing and balancing is critical to ensure maximum operating efficiency while providing comfort to the occupants. Some buildings also may require balancing throughout the year as the system switches from heating to cooling mode and vice versa.

(continued on next page)

Certification and Clean-air Measurements

Monitoring air conditions is a major concern in clean environments since they need to meet more stringent requirements. Air measurement verification has become mandatory for many laboratories and facilities, and can be subject to government regulation and inspection.

For critical electronic component manufacturing, food and beverage processing, pharmaceutical production, and other critical environments, quality of ambient air can directly impact product quality and economic bottom line.

Laboratory fume hoods, biological safety cabinets, industrial hoods, and spray-paint booths are typical applications where measuring and maintaining proper air velocities are critical to safe, healthy working conditions. Beyond the need for human comfort and safety, exposure to dangerous, infectious or contagious material must be controlled. Ventilation and correct air flow distribution are vital to maintaining product quality and yield.

IAQ

Indoor Air Quality is another significant factor that may impact occupant comfort-productivity-health, product quality, and in some cases affect building structural integrity. Indoor Air Quality encompasses a number of air parameters including, but not limited to, relative humidity, temperature, air circulation, outside air concentration, volatile organic compound concentration, and fume/vapor dispersal.

Humidity should be periodically monitored to ensure it stays between 20 and 60 percent, the generally accepted ASHRAE guidelines. CO₂ levels are an important indicator of indoor air quality. Elevated CO₂ levels can be indicative of inadequate ventilation which can also increase the levels of volatile organic compounds which may affect the health and safety of building occupants.

There are a number of instruments on the market today that accurately measure humidity and CO₂ levels. Many incorporate multiple air measurement parameters, maximizing their value and minimizing the impact on your equipment budget.

MEASUREMENT INSTRUMENTATION

Capture Hoods

The volume of air emerging from grilles and diffusers is a critical measurement in HVAC systems. Such measurements were traditionally taken using a deflecting vane anemometer with a diffuser probe and applying the diffuser manufacturer's "A_k" factors. Capture hoods have replaced the deflecting vane anemometer with diffuser probes due to their ease of use, quick measurements, and near elimination of the need to apply grille manufacturers "A_k" factors. It still may be necessary, however, to develop a correction factor to apply to the measured reading to compensate for the varying duct and diffuser outlets encountered in the field (see Appendix C). Primary benefits for air balancing using capture hoods include one-step direct volume measurement, time savings, ease of use, and convenience.

Capture hoods can be configured with various sizes of fabric skirts and frame supports to fit different diffuser and grille configurations. The hood "captures" all air exiting from a diffuser or grille and guides it through a sampling manifold which has evenly spaced inlets to average the flow through the manifold. These instruments are used on both supply and exhaust outlets with separate calibrations for each mode performed at the factory.

Mechanical (Analog) Capture Hoods

With a mechanical capture hood, air flows from the sensing manifold through a mechanical, user adjustable, range selector and finally to a deflecting vane anemometer that reads directly in cubic feet per minute. Analog models require no batteries or power supply and can be used on ceiling, sidewall, and floor outlets. When using an analog capture hood, verify the unit is reading zero in the position it is to be used. The zero adjustment screw can be used to adjust the pointer on the meter to read zero in any position.

- Simple-to-read analog meter allows for quick measurements.
- Easy-to-carry with one hand using sturdy middle handle.
- Ergonomic design and ultra-light weight for easy one person operation.
- Multiple hood sizes available.
- Measurement hold function.
- Wheeled, luggage-style carrying case
- Multiple hood sizes available.



Model ABT701 and ABT711



Model ABT703 and ABT713

Smaller, more compact analog models are available with varying hood sizes. The lower profile hoods are useful in tight quarters such as over filing cabinets, heavy equipment, and office partitions as well as for residential applications.

- Interchangeable hoods mount directly to the base which contains the averaging manifold, range selector and meter.
- Hoods may incorporate a selection knob to select both flow direction and range, allowing the mechanical hood to measure either supply or return diffusers.
- A low flow adapter screen attached to the base of the mechanical hood allows measurements with better resolution on systems which incorporate low volume diffusers.
- Hoods have a zero adjustment screw on meter assembly.
- They use a swinging vane, pressure based sensing method.

Digital Capture Hoods

Digital capture hoods operate under the same basic principle using skirts, frames, and averaging grids. However, the sensing technology is different. Instead of having the mechanical range selector, most digital hoods are auto ranging. The sensors used to measure the flow through the manifold can be a thermo-anemometer (hot wire) sensor or a pressure sensor. The hot wire format provides a quick response and continuous readout on the LCD display. Digital hoods display standard air volume rate when placed at supply or return diffusers, registers, or grilles located on the ceiling, wall, or floor.

Small digital capture hoods are available that are mainly used in residential or light commercial applications for taking measurements from 10 to 500 cfm (17 to 850 m³/h). The compact size allows them to be used where full size hoods would not fit. For example, the LoFlo Balometer® hood is battery powered and may be used with or without the optional 16 × 16 in. (40.6 × 40.6 cm) and 2 × 2 ft (61 × 61 cm) hoods.

- These hoods may have combination analog/digital displays.
- A vent mechanism reduces the flow restriction caused by the instrument. This venting system allows the instrument to remain compact and still measure a wide range of volume rates.
- These hoods are lightweight.
- They utilize thermo-anemometry sensing technology.



LoFlo Balometer® hood

Digital Capture Hoods with Differential Pressure Sensor

The same principles, general configuration, and optional hood sizes used on the previous capture hood examples also apply to digital hoods that use a differential pressure manometer and averaging manifold as the display and base sensor.

Pressure based digital hoods are popular with test and balance professionals due to the versatility of the instrument. Pressure sensor-based capture hoods commonly contain zeroing valves which automatically zero the pressure sensor during normal operation. The meter is a manometer that can be detached from the hood assembly and used with common HVAC pressure-based testing probes such as a pitot tube, velocity matrix, air probe, and static pressure probe. Additional measurements for relative humidity and temperature can be obtained by attaching optional probes to the meter which further enhances the versatility of the instrument. These hoods typically offer the following:

- Ergonomic, lightweight design enables easy one-person operation.
- Automatic sensing and display of supply or return flows saves time on the job.
- Back pressure compensation ensures accurate readings at high flow rates.
- Detachable digital micromanometer provides additional measurement capability.
- Multiple hood size options enable measurement of different outlet dimensions.
- Compatible LogDat™ Mobile Remote Reader and Data Logger Software option simplifies documenting of results and emailing of reports.
- Capture hood stand eliminates the need for ladders (reaching diffusers up to 15 ft. (4.5 m)).



Model EBT731 Balometer® hood
(Shown with standard and optional accessories)

Thermo-Anemometers (Hot-Wires)

Thermo-anemometers, also known as “hot wires,” operate on the principle of heat transfer. A sensor is heated above room temperature by passing current through an electrical resistance and the energy is converted to heat. Through convective heat transfer, the heat is transferred to air passing over the heated element. The electronics provide more power to the heated wire to maintain the initial temperature at zero flow, and this increased power curve signal is converted to a velocity reading on the display.

Thermal anemometers accurately measure a wide range of velocities, anywhere from 10 to 10,000 fpm (.05 to 51 m/s). They have small probe diameters which allow them to be placed in tight areas, such as measuring air velocity in between circuit boards in a PC or in small ducts. Thermo-anemometers have air temperature limitations. Most units have a maximum temperature of approximately 180 to 200°F (82 to 93°C), which generally limits their use to ambient conditions.

Thermo-anemometers are commonly used to measure velocity in paint spray booths, laminar flow hoods, air flow system balancing and duct traverses, pharmaceutical manufacturing areas, clean-room biological safety cabinets and fume hood testing, room air currents, and draft measurements.

Basic Thermo-Anemometers

These small, compact models are useful for general air velocity measurements. Velocity ranges are typically less than 4000 fpm (20 m/s) and temperature measurement capability along with a telescopic probe may be available on some models. Most models offer the following:

- Low cost instruments with good accuracy.
- Available with a digital LCD or analog meter readout.
- Available as intrinsically safe models.
- Available in English or metric models.



AVM410

Thermo-Anemometers with Mathematical Calculations

These models are commonly used to perform duct traverses and face velocity measurements of fume hoods and HEPA filters due to their ability to take multiple measurements and to average the readings. Optional portable printers can be used with these instruments to print test data in real time. They usually provide the following:

- Wide velocity and temperature range.
- Velocity to volume flow conversion based on duct dimensions.
- Telescopic or telescopic articulated probes.
- User-adjustable dampening or time response settings.
- English or metric readout capability.



AVM430

Comprehensive Thermo-Anemometers

These models provide the same accurate velocity and temperature measurements as the other models. Additional functions include humidity measurement in %RH and conversions to wet bulb and dewpoint temperatures. A data logging function allows the user to program the number of samples to be taken and the time interval between samples. This can be a very useful feature when tracking trends over a period of time. These meters offer the following:

- Segregate data groups in separate test IDs.
- Recall stored data on instrument display.
- Download stored information to a PC or portable printer.
- Offer telescopic or telescopic articulated probes.
- Perform density correction.
- Have backlit LCD display.



AVM440

Rotating Vane Anemometers

A rotating vane anemometer is similar to a small windmill where airflow impinges on the vane creating rotation. It is useful for measuring air velocity at supply openings, but not for multiple throw diffusers. A characteristic of the rotating vane anemometer is its ability to average air velocities over an area. It is most commonly manufactured in four-inch-diameter versions which generally prevents its use for measuring duct velocity. However, it has been found useful in walk-in ducts and on large filter banks.

Like most air measuring instruments, the rotating vane anemometer is subject to errors due to angle of attack, but these errors are small. A one percent error is typical for ± 12 degrees. These instruments read in actual feet of air at its existing density which results in actual fpm (m/s). If standard fpm (m/s) is desired, simply multiply the anemometer reading by the actual density divided by standard density. The rotating vane anemometer must be handled with care, since it cannot survive rough treatment. Likewise, it should not be used in dusty or corrosive environments.

Mechanical Rotating Vanes

The mechanical rotating vane anemometer incorporates a revolution counter that is engineered and calibrated to read air velocity directly in feet of air. To use this instrument, hold it directly in the air stream, permitting the rotating blades to get up to speed, then start the counter and let it run for a specific amount of time (at least 30 seconds) as timed by a watch which accurately indicates time in seconds. The “feet of air” (“meters of air”) reading on the dial, divided by the time in minutes, gives the average velocity in fpm (m/s).

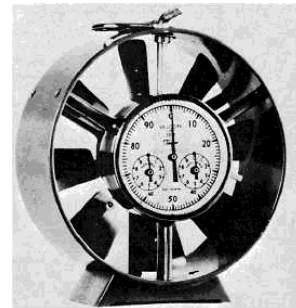

Mechanical Rotating Vane

Digital Rotating Vanes

Electronic versions of the rotating vane anemometer are prevalent today. The fan blade rotation is sensed by a magnetic or optical pickup and the signal is converted to a direct fpm velocity readout. Digital models have less bearing friction than mechanical vanes, allowing for accurate measurement from 50 to 6000 fpm (0.25 to 30.5 m/s). A directional arrow located on the vane head identifies the flow direction used during factory calibration and should always be pointed in the direction the airflow is traveling when used in field applications.

Handheld models may incorporate a user-adjustable, swivel head, which can be used for taking readings in supply or exhaust openings while allowing the operator to view the display regardless of flow direction. Models with telescopic, articulated probe assemblies allow for a longer reach for measuring air flow in a hard to reach area such as a return grille mounted on a wall or above filing cabinets. They also offer the following:

- Minimum, maximum, and averaging capabilities.
- Air temperature measurement.
- Direct conversions to cfm or m^3/h by inputting the free area in square feet into the instrument.
- Data logging and memory storage functions for higher end models to enable later data recall or downloading to a PC or portable printer.



RVA801



RVA501

Deflecting Vane (Swinging Vane) Anemometers

The deflecting vane anemometer is a mechanical instrument based on technology developed in the 1930s and is still widely used in the field today due to its ease of use, portability, direct readings in velocity units, and ability to operate with no batteries or power supply.

The moving element consists of a pointer and a vane mounted on a taut-band suspension. This allows the vane to swing inside an air chamber and its movement is virtually friction-free. The flow through the instrument is created by the velocity pressure at the point being measured, which is converted to readout in actual fpm (m/s). Like other mechanical instruments, it should be handled with care.

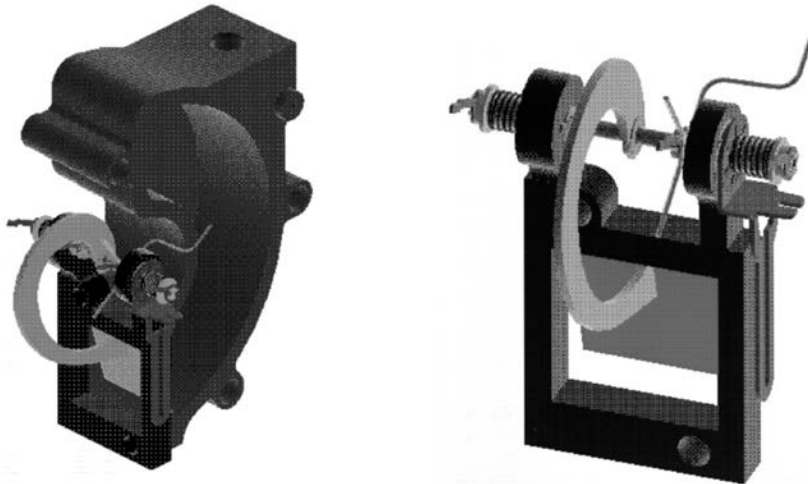

Cut away view of the deflecting vane and tunnel assembly

Velometer Jr

The deflecting vane anemometer is also available in a smaller hand-held size intended to be placed directly in the air stream. Its compact size makes it convenient for measuring airflows at registers, fume hoods, doorways, and at spray booths and refrigerated display cases commonly found in grocery stores.



Velometer Jr

Manometers

Taking pressure measurements in HVAC systems has been a standard method of checking system performance in mechanically ventilated buildings for many years. Manometers are instruments used to measure low pressures, such as duct static pressures and differential pressures, across filters or between rooms. When connected to a pitot tube, velocity pressures can be measured in ducts and then converted to velocity or volume units of measure.

Digital Micromanometer

The most popular type of manometer today is a digital micromanometer. Like a liquid manometer, this instrument is a differential pressure measuring device. It can be used with any standard pitot tube to measure static pressure, velocity, or volume. A digital micromanometer can be used in any position and does not require leveling. However, it should be zeroed periodically throughout a workday.

Most digital micromanometers measure pressure and velocity in English or metric modes and include averaging capability. High end units can directly measure flow in cfm (cubic feet per minute) or m³/h (cubic meters per hour) by inputting duct dimensions for round or rectangular configurations. They also offer:

- Data logging or memory storage for later data recall.
- The ability to download stored data to a PC or printer.
- Adjustable dampening or time response settings.
- Density correction for temperature and barometric pressure to compensate for elevated temperatures and altitude.



AXD620 Micromanometer with Pitot Tube

(continued on next page)

Digital Auto-Zeroing Micromanometer

Auto-zeroing micromanometers are similar to standard digital micromanometers in that they do not require any kind of leveling and are not position sensitive. However, micromanometers with an auto-zeroing function along with a high resolution pressure sensor measure lower pressures and velocities with higher accuracy than standard digital micromanometers. This allows them to be used with a variety of different pressure based probes in addition to the standard pitot probe. Auto-zero micromanometers provide the following:

- Accurate measurement of pressure, velocity and flow complies with industry standards.
- Auto-zeroing pressure sensor reduces user-steps and saves time.
- Automatic density correction increases reading accuracy.
- Large, backlit graphic display offers easy-to-use interface.
 - Up to five simultaneous measurements
 - On-screen messages and instructions
 - Multi-language capability
- Intuitive menu structure simplifies operation.
- Bluetooth bi-directional communication eases data transfer and permits use of LogDat Mobile Remote Reader and Data Logger Software for Android devices.
- Optional pitot, air flow (straight pitot), temperature/relative humidity, velocity matrix, or plug and play thermoanemometer probes enables use in multiple applications.



EBT730 Micromanometer (Micromanometer shown with standard and optional accessories)

Pitot Tube

Pitot tubes are used with manometers to sense total and static pressures in ducts and plenums. The pitot tube is a simple, rugged probe and, if properly constructed, requires no calibration. However, it must be properly maintained. A small buildup of dirt around the static holes can cause instrument errors in both directions. Small leaks in the tubing connection or the tube itself can also cause substantial errors.

Pitot tubes are double-walled tubes typically fabricated from stainless steel. The inner tube senses the total pressure, and the outer tube senses the static pressure. The difference between the total pressure and the static pressure is referred to as the *velocity pressure*, which can be converted to velocity in fpm (m/s). Measuring velocity pressure using a pitot tube is accomplished by connecting rubber hoses from the total and static pressure legs of the pitot tube, to the positive and negative ports of the manometer, respectively.

- Total Pressure (P_t): the sum of the impact caused by velocity pressure plus static pressure in the duct
- Static Pressure (P_s): exerted equally in all directions
- Velocity Pressure (P_v): the pressure required to accelerate the air stream to its velocity, determined by subtracting static pressure from total pressure

$$P_v = P_t - P_s.$$

Standard equations can be used to convert velocity pressure to velocity (fpm or m/s) by taking into consideration both air density and humidity. Once the velocity pressure is known, the following formula can be used to convert to velocity:

$$\text{fpm} = 4005 \times \sqrt{\Delta P} \quad \Delta P = P_v \text{ or differential pressure in inches H}_2\text{O}$$

or

$$\text{m/s} = 1.29 \times \sqrt{\Delta P} \quad \Delta P = P_v \text{ or differential pressure in Pa}$$

The pitot tube is subject to error due to the angle of attack and yaw, so its use is generally limited to reading velocities inside ducts, where the direction of air flow is relatively well controlled. It is usually not a good choice for taking readings at supply openings because of the drastic changes in air flow direction at, or immediately ahead of, the opening. In general, it is not appropriate for measurements at an exhaust opening or in an open space. The stainless steel construction allows it to be used to measure air velocities with high temperature applications. Stacks, flues, chimneys or other combustion processes are a few examples of measuring air flows at elevated temperatures.

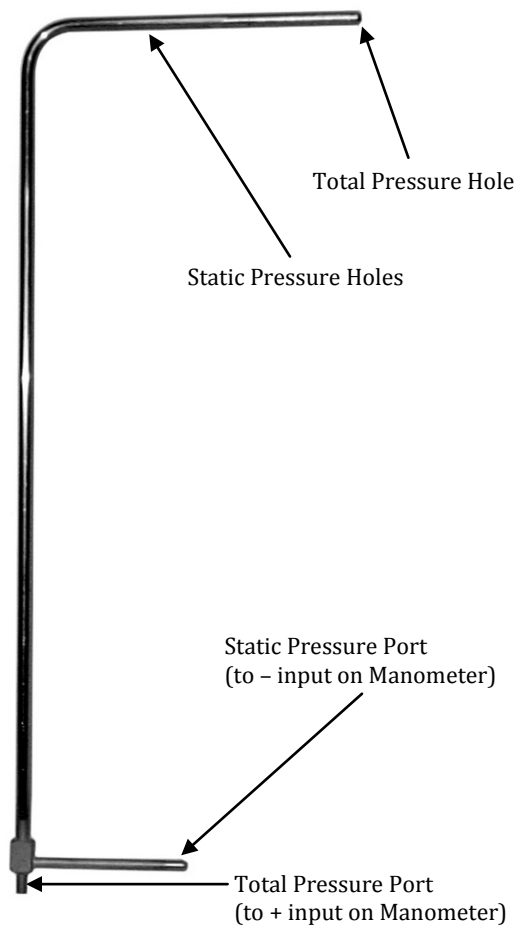

Hydronics

Hydronic systems found in HVAC configurations primarily use hot and chilled water as the means for heat transfer. The hydronic system must be able to efficiently distribute water to all terminal devices under design load and part load conditions to be considered operating properly. If the system is not balanced for design conditions, then the cost to operate the system will be higher than anticipated.

Correctly balancing a hydronic system requires the proper tools and procedures. Manual balancing valves installed in the system are typically used to regulate flow to all points to achieve design conditions. Flow control through the balancing valve is accomplished by adjusting a valve to vary the differential pressure across it.

Hydronic manometers or pressure gauges can be connected to pressure taps on the balancing valves to measure the differential pressure across the valve, which then can be used to determine flow. The flow-rate is determined by taking the differential pressure reading across the manual balancing valve and applying it to a *pressure versus valve setting* chart (developed by the valve manufacturer).

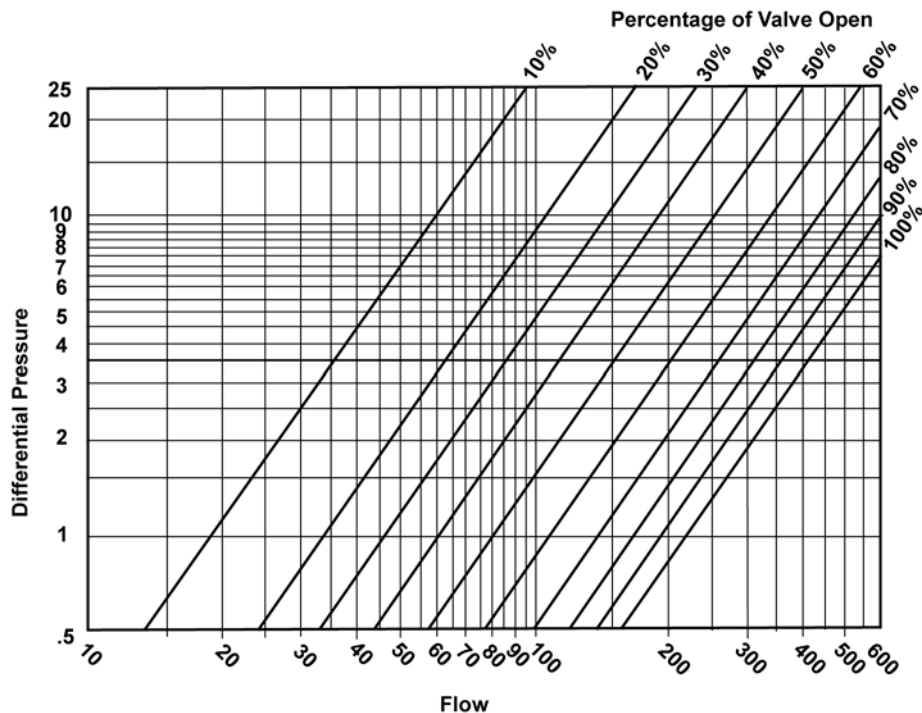

Example of a conversion chart for a balancing valve

Mechanical Gauges

Mechanical gauges are simple devices, available in various scales and measurement units. If certain applications require readings in PSI, ft H₂O, in. H₂O with varying ranges (0 to 25, 0 to 50, 0 to 100, etc.), then several different models would be utilized to maximize resolution and accuracy. Common refrigeration hoses with Schraeder-type fittings are typically used with these gauges.

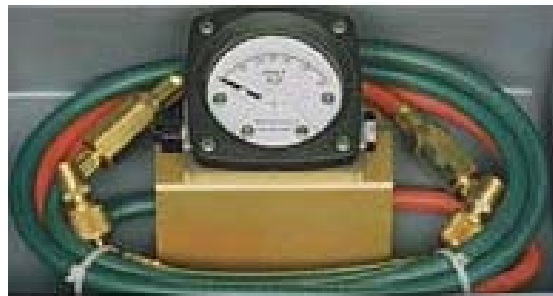

Mechanical gauge with hoses

Digital Hydronic Manometers

Digital hydronic manometers have features such as multiple units of measurement in English or metric, wider ranges with good accuracy and resolution, and large LCD displays. A single unit replaces multiple mechanical gauges. Digital models require a power source such as a plug-in AC power supply, disposable alkaline batteries, or rechargeable batteries with separate charging station. Standard refrigeration grade hoses and fittings with shut off valves are also used with digital models.

- These units have a backlit display for poorly lit areas.
- They offer memory, recall, datalogging, and downloading functions.
- They have user-adjustable dampening or time response settings.
- Some hydronic meters also perform flow and other calculations.



Hydronic Manometer measuring the pressure rise across a pump



HM685 with hoses

IAQ: Ventilation and Carbon Dioxide

A good indicator of proper ventilation is the level of CO₂ present in a space. Carbon dioxide is a normal byproduct of respiration, combustion and other processes. Elevated levels of CO₂ may indicate that additional ventilation is required. Higher CO₂ levels may also indicate more investigation is required regarding ventilation, thermal comfort, or source control. Inadequate ventilation can increase volatile organic compound levels in the ambient air which can affect occupant comfort and health.

The measurement of carbon dioxide concentration relies on one of the natural properties of CO₂ molecules: they absorb light at a specific wavelength of 4.26 μm, a wavelength in the infrared (IR) range. High concentrations of CO₂ molecules absorb more light than low concentrations. The technique used to measure CO₂ in handheld instrumentation is called non-dispersive infrared (NDIR) detection.

Continuous Emission Monitors

Continuous emission monitors, or CEMS, are a class of electronic instruments designed to measure exhaust stack gases and temperature continuously. CEMs are sometimes used for combustion control, but typically are used for monitoring pollutant gas emissions as required by government regulations. CEMs can use both extractive and *in-situ* (sensors in the stack) sampling methods, and employ a variety of electronic sensor technologies for gas detection. CEMs are used most often on larger installations or when required by regulatory agencies.

MEASUREMENT BASICS

HVAC System Performance

Measuring Air Velocity and Air Volume at Supply Grilles/Diffusers

Supply flow into an occupied space is generally a mixture of return air and fresh outdoor air that has been filtered and then conditioned through heating or cooling coils. This volume of supply air will become entrained with the room air at a known rate in order to achieve occupant comfort by providing sufficient volume flow to satisfy the number of occupants in a given space. The flow rate requirements for a room or building, and the percentage of outdoor air versus return air being delivered will vary depending on the principle purpose of the facility (see *Appendix D, "Determining the Percentage of Outside Air using either Temperature or CO₂ Measurements"* for more information).

It is very important to verify proper manual and automatic control of an HVAC air system. A balanced supply and exhaust will help ensure sufficient ventilation by meeting minimum air exchange rates, removing airborne contaminants which can affect air quality, and reducing operating costs. The supply flow for an area may also affect the room pressurization in relation to an adjacent room or hallway, which can cause drafts or difficulty opening and closing doors.

Capture hoods, rotating vanes, and thermal anemometers are the most common choices used to verify proper minimum flow rates; confirm proper operation of dampers, controls, and fans; and ensure the efficient use of energy.

Capture hoods are popular instruments to use for measuring flow rates from supply grilles. Since they obtain measurements quickly, provide a direct air volume reading, are easy to use, and come with a variety of hood sizes to match various grilles, capture hoods are often the tool of choice (when measuring supply).

ASHRAE recommends performing a duct traverse to determine if a correction factor is needed for air capture hood measurements. Different diffuser styles, elbows attached directly to the diffuser, and dampers located just upstream of the diffuser can impair the uniformity of the flow patterns coming out of the diffuser and affect the hood reading. Be sure to choose the hood size that most closely matches the outlet size being measured. Many capture hoods on the market today include an A_k -factor function.

Utilizing these instruments effectively can help you ensure the proper balance of mechanical HVAC system supply air flows. Additional information can be found in Appendix B, "Flow Resistance," and Appendix C, "Characterizing a Capture Hood to an Outlet."



EBT731 Balometer® hood measuring a supply diffuser

Nonuniform Flow Corrections

Using a capture hood on a supply opening with no diffuser or deflecting vanes may not provide accurate results due to a nonuniform air pattern and jet effects. Capture hoods are generally calibrated on a wind tunnel with a 2 × 2 ft (61 × 61 cm) hood attached to a diffuser or grille. The diffuser or grille spreads out the air flow and the capture hood will see more uniform flow. Other instruments are often used instead of capture hoods for nonuniform air flow applications.

Other suitable instrument types for this application include rotating vane, thermal anemometer, velocity matrix and swinging-vane anemometers.

Measuring air velocities at a supply opening is easily accomplished when no grille or louvers cover the opening. Divide the opening into sections of equal area (refer to Appendix A) and take a measurement in each section. Instruments used for this application can be a rotating vane anemometer, velocity matrix, deflecting vane anemometer, or thermo-anemometer. Add the readings and divide the sum by the total number of readings to determine the average.

If the supply opening is covered with a simple grille which provides at least 70 percent free opening and there are no turning vanes, a rotating vane anemometer is a common choice. The best procedure is to divide the grille into equal areas and to take a reading at each grille section for at least 30 seconds for a mechanical instrument and 10 to 15 seconds for a digital instrument. The rotating vane anemometer will average the velocity during this timing interval, giving a more stable result. However, the lower the velocity, the longer it may take for the vane to stabilize.

A velocity matrix provides a larger measurement area, reducing the total number of samples resulting in quicker measurements. The velocity matrix can be used on a supply opening with no grill or louvers, but may not be the best choice if there are turbulent air flows. They can cause some turbulent air patterns which could affect the averaging function of the grid pressures.

Many diffuser manufacturers have established A_K -factors and procedures applicable to their outlets for correcting measurements taken with a deflecting vane anemometer equipped with diffuser probe. Probe positioning performed in the same manner as was done in the laboratory is critical in achieving reliable measurements in the field using this technique. The flow rate is determined by multiplying the diffuser manufacturer's A_K -factor by the average velocity in fpm (m/s) to obtain cfm (m³/h).

$$Q = A_K \times V$$

Where:

Q = flow rate in cfm (m³/h)

A_K = outlet manufacturer's correction factor

V = average velocity in fpm (m/s)



Rotating vane measuring an outlet



Diffuser measurement using a diffuser probe and deflecting vane anemometer



Velocity matrix measuring face velocity of an HVAC filter

Since the introduction of the capture hood, the deflecting vane measurement has become less prevalent. It is a good option for low flow applications.

Static Pressure Measurement

Static pressure measurements are an important method of determining system operating efficiency and identifying problems such as leaky ducts, clogged filters and coils, and blocked inlets. Any of these can negatively affect occupant comfort and system operating efficiency which can waste significant utility dollars. Unnecessary increased loads on fans and other system components can cause premature wear and untimely failure, resulting in increased maintenance costs.

Static pressures in air distribution ducts can be measured using a digital micromanometer, incline manometer, or deflecting vane anemometer with static pressure probe. A digital micromanometer or incline manometer can use the standard “L-shaped” pitot probe with a hose connected from the positive port of the manometer to the static pressure leg of the pitot probe. The total pressure leg of the pitot probe and the negative port of the manometer would be open to the atmosphere.

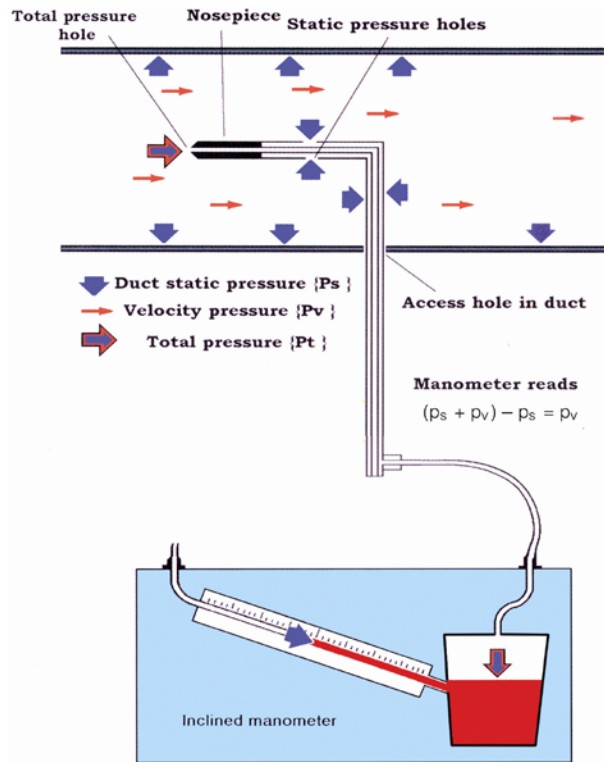

Duct static pressure measurement

Exhaust Grille Measurements

To adequately balance a mechanical HVAC system, it is necessary to also verify exhaust flows. Instruments such as a capture hood, rotating vane, or velocity matrix are common choices to measure exhaust flows.

Capture hoods calibrated for exhaust mode can be used on return grilles without an A_k -factor. For the best accuracy, choose the hood that most closely matches the outlet size being measured and set the hood to exhaust or return mode. Also, as with supply diffusers, an alternate means of measuring flow (such as a duct traverse) is advised when determining if a correction factor needs to be applied to the hood readout.



Balometer® hood measuring a restroom exhaust

For more information, see *Appendix B* on Flow Resistance and how to compensate for this affect. *Appendix C* contains information on Characterizing a Capture Hood to an Outlet.

Rotating vanes can be used on return grilles provided the vanes of the grille are straight with no deflection. Place the rotating vane approximately 1 to 2 inches (2.5 to 50 cm) away from the grille and divide the face of the grille into equal areas (refer to Appendix A) with the vane head taking a measurement in each location. The readings should be added and the sum divided by the total number of readings to obtain an average velocity. The average velocity can be multiplied by the free area of the grille in square feet (square meters) to obtain a cfm (m^3/h) volumetric value. Rotating vanes are a good alternative if the grill is too small or too large to accommodate a capture hood.

A velocity matrix is a good choice for large return grilles with high flow rates that a capture hood cannot accommodate. The face of the return grill should be divided into sections (refer to Appendix A) and the velocity matrix placed in each section to obtain a reading. These readings should be added and then divided by the total number of readings to produce an average velocity. Stand-offs located on the corners of the velocity matrix aid in positioning the matrix for repeatable results by keeping the distance between the matrix and the grill consistent for each measurement.

If the exhaust outlet does not have a grille or louvers, divide the face into a grid pattern with equal areas (refer to Appendix A). A larger number of measurement locations may be required to increase the accuracy of the average flow. Measurements can be taken in the center of each area using a velocity matrix or rotating vane anemometer. However, the blockage effect caused by the size of the instrument when placed in the air stream at the exhaust opening will vary from model to model, and the accuracy may be impaired.

Duct Traversing: Low to High Velocities and at High Air Temperatures

Air velocity measurements are often taken within ducts to determine flow rate. Since velocity distribution is not uniform even in the best of circumstances, a duct traverse is necessary. This involves taking a number of readings within the duct and determining average velocity.

For selecting the most appropriate technique, here are some general guidelines. If air velocity in ducts normally exceeds 1,000 fpm (5 m/s), a manometer with pitot tube, thermo-anemometer, or deflecting vane anemometer with pitot probe can be used for making these measurements. However, each instrument has its limitations and may not be applicable for all jobs.

- If velocities are below 700 fpm (3.5 m/s), the choice of instruments would be between either the deflecting vane anemometer with pitot probe or a thermal anemometer.
- If velocities are below 300 fpm (1.5 m/s), the thermal anemometer may be the only choice. An example is a vertical stack or flue that functions as a result of temperature differences and may contain combustion or industrial process by-products.
- Measuring air flow in extreme air temperatures found in chimneys or drying oven ducts will require a manometer with stainless steel pitot tube that is rated up to 1500°F (815°C).



Duct traverse with Micromanometer and pitot tube

NOTE: The manometer is not considered to be a flow through device. This means the elevated air temperature seen by the pitot tube will not pass down through the hoses to the manometer and damage components or electronics. However, if the probe is left in the high temperature airstream for extended periods, high temperatures may eventually affect the tubing connecting the manometer to the pitot tube.

See *Appendix A* for the procedure on how to perform a duct traverse using either a thermo-anemometer, micromanometer with pitot probe, or deflecting vane anemometer with pitot probe.

Measuring Air Velocity in Open Areas

Air velocities (and movement) in a room or space are often felt as a draft and, depending on the intensity, can be uncomfortable to most people. Cross-drafts in areas having spray booths or lab hoods can interfere with air measurement by the permanently installed air velocity monitors on the booth or hood. These and similar situations call for an air velocity measurement in the range of 50 to 200 fpm (0.25 to 1.00 m/s).

- Thermal anemometers are generally the first choice for accuracy, but are inappropriate for determining air flow direction. A smoke source can be used in conjunction with the thermo-anemometer to provide an indication of flow direction.
- A deflecting vane anemometer can also be used in most open areas for measuring velocity. To obtain an accurate reading, hold the instrument in the air stream with the proper port facing upstream. If the flow direction is not known, orient the instrument in various positions until you obtain maximum deflection.
- An air velocity transducer capable of outputting an analog signal (voltage or current) along with an omni-directional thermo-anemometer sensor can be used to measure room currents or draft over a period of time. The analog output signal can be connected to a remote datalogger to track trends in air patterns throughout the day, week, or month in order to get a better understanding of where and when room air currents are unacceptable.

Testing and Certification

Differential Pressure Measurement Between Two Rooms or Areas

Room pressures can be measured using a micromanometer to determine if one room is at a different pressure than an adjacent room or hallway. Isolation rooms in hospitals, for example, maintain a negative pressure differential in relation to an anteroom or corridor in order to contain the spread of infectious or contagious diseases.

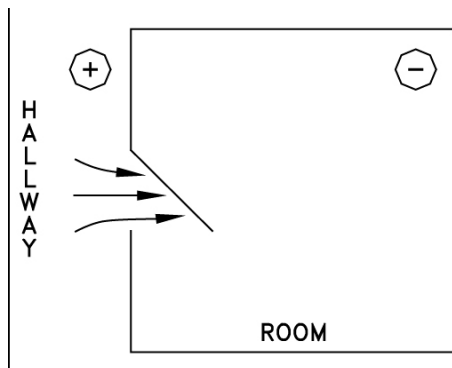

Negative room pressures are present when air flows from the hallway to the room

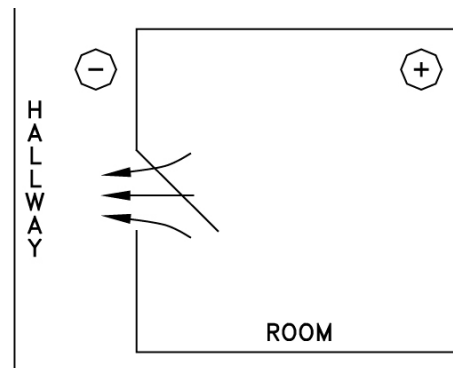

Positive room pressures are present when air flows from the room to the hallway

To measure the pressure differential from the corridor or anteroom, zero the micromanometer and connect one hose to the *positive* port and run it under a closed door a few feet to the inside of the isolation room or through a port drilled in the wall connecting the two areas. Since the isolation room has a negative pressure, the reading displayed on the micromanometer will be a negative value, giving you the pressure differential between the two areas. The corridor pressure should be at least 0.01 inches of H₂O (2.5 Pa) greater than the pressure of the isolation room.

Spray Booths

There are a number of applications in industrial plants which require air flow measurements at exhaust openings to satisfy minimum requirements for comfort or safety. The most common is a spray booth where the generally acceptable average velocity is 100 fpm (0.51 m/s) and air must be moving *into* the booth at that velocity. An exhaust fan connected to the spray booth duct creates a negative pressure in the booth, resulting in ambient air outside the booth being drawn into the booth to mix with the vapors. The combined air mix then flows up the exhaust duct.

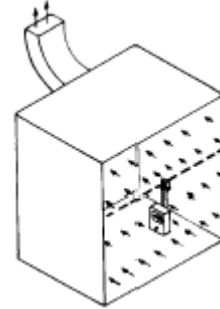

A thermo-anemometer with a telescopic articulated probe, deflecting vane anemometer with a low-flow probe, rotating vane anemometer, or velocity matrix can be used to test spray booths.

- A thermo-anemometer with an averaging feature and datalogging is best suited for this type of measurement.
- The velocity matrix will produce the quickest results.

Laboratory Hoods

Laminar flow benches and laboratory chemical fume hoods typically have average face velocities in the range of 100 to 120 fpm (0.51 to 0.61 m/s) in which no individual face velocity measurement can vary more than 20 percent from the average. This is necessary to ensure the safety of the hood user and to prevent unwanted contaminants from escaping the confines of the hood.

The hood opening is divided into a grid pattern with one square foot sections. The instrument probe is positioned in the center of each section to obtain a reading. When all the measurements have been taken, they are added and divided by the total number of readings to obtain an average velocity. ASHRAE Standard 110 has more detailed information pertaining to the lab hood certification process and should be used as a reference.

A thermo-anemometer with a telescopic articulated probe, deflecting vane anemometer with a low-flow probe, or a rotating vane anemometer can be used for this type of measurement.

- A thermo-anemometer with an averaging feature and datalogging is best suited for this type of measurement during the certification process.
- The velocity matrix will produce the quickest results.

Divide the hood face into a grid with 1 ft² (0.09 m²) sections and take a reading in the center of each.

Add the readings and divide by the total number of readings to obtain the average face velocity.

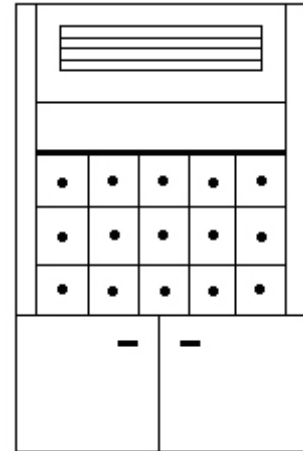

Unit Ventilators

These are self-contained HVAC systems commonly found in hotels, motels, and schools and used in retrofit situations on older buildings. Measuring the flow rate of a unit ventilator will confirm proper operation for comfort and operating efficiency. Caution is recommended when making the measurements from the outside since wind and cross drafts can affect the accuracy of the instrument readings.

- A capture hood using a 1 × 4 ft (30.5 × 122 cm) or 1 × 5 ft (30.5 × 152 cm) hood will provide a direct volume readout in cfm (m³/h).
- Rotating vane anemometers can also be used to perform this type of measurement. The average velocity measured by the rotating vane can be multiplied by the free area in ft² (m²) to obtain a volumetric cfm (m³/h) result.

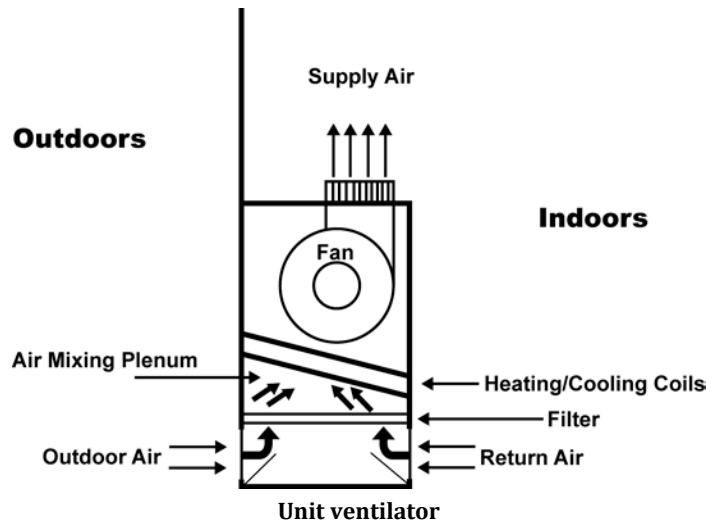

Measuring Slot Velocities

Measurements of slot velocities are often required in industrial applications where local exhaust ventilation is required. Examples of this are the ventilating slots at an open plating tank, or the slotted hood over a welding bench. Slot velocities tend to be in the range of 1,500 to 2,500 fpm (7.6 to 12.7 m/s). A thermal anemometer or deflecting vane anemometer equipped with a pitot probe is the best choice for this type of work.

- If multiple measurements are required, a thermal anemometer with datalogging functionality would be the choice.
- Thermal anemometers have a small probe diameter, which is useful on small suction openings. However, this does not mitigate the variable direction of flow in front of the opening, nor does it eliminate the problem of translating fpm (m/s) to cfm (m³/h) in the rapidly changing cross-sectional area of the air stream.
- The deflecting vane anemometer will provide a quick trend analysis of high and low velocity points across the plane of air flow.
- If greater accuracy is required, locating a suitable measuring station in the ductwork downstream from the slot will be necessary.

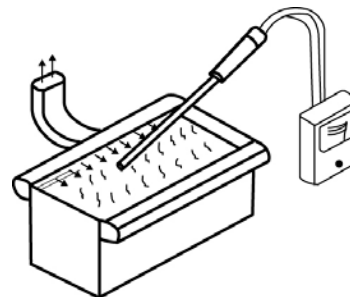

Measuring velocities at plating tanks using a deflecting vane anemometer with pitot probe

Clean Room Testing and Certification

A clean room is defined as a work area in which the air quality, temperature and humidity are highly regulated in order to protect sensitive equipment from contamination. Clean rooms are important in the production of silicon chips, hard disk drives, and many other products. The air in a clean room is repeatedly filtered to remove dust particles and other impurities that can damage highly sensitive devices during production.

Regular testing of a clean room facility should be scheduled on a quarterly, semi-annual or annual basis to identify significant changes in efficiency. This will ensure changes are addressed before they become a major source of contamination, affecting productivity. Some of the recommended HVAC testing includes the following:

- Filter velocity and uniformity.
- Differential pressures.
- Temperature and humidity.
- Rebalancing of the supply/return air system.
- Air pressure balancing/rebalancing of critical areas.
- Room air change calculations.

Instrumentation commonly used to perform the above mentioned testing includes air capture hoods, micromanometers with a velocity matrix or pitot probe, thermal anemometers, and hygrometers.

Certification is a sequence of comprehensive tests performed on contamination control equipment to assure top-level efficiency of all units. Refer to applicable regulations, such as NSF49, for more information on clean room certification. Be sure to review any applicable industry and safety requirements to ensure the instruments that you use meet the criteria for certification.

Thermal Comfort and IAQ

Air Temperature Measurement

Measurements should be taken periodically in many areas of a building to ensure air is distributed evenly and temperatures are at desired levels. Air temperature is one of the main air quality components affecting occupant comfort and directly relates to productivity and overall operating costs.

Allow sufficient time for the instrument to capture a “stable” reading when taking temperature measurements within an occupied space. If you move from a hot area to a cold area and quickly take a temperature measurement, the accuracy of the reading may be questionable. Temperature measurements performed in a duct require less time to stabilize due to the air velocity in the duct which accelerates the stabilization process.

- Thermo-hygrometers, thermo-anemometers or glass and alcohol thermometers are commonly used to obtain temperature readings.
- For monitoring temperature over a period of time when investigating complaints that occur on an intermittent basis, a thermo-hygrometer is the best choice. The information logged to memory can then be downloaded for analysis.

Information on determining the percentage of outside air using temperature measurements can be found in *Appendix D*.

Relative Humidity Measurement

Relative humidity also affects occupant comfort, productivity and operating costs. Relative humidity measurements taken in various areas within a building are influenced by outdoor air conditions, human activity, HVAC controls, and other factors. A single indoor measurement might not reflect what is happening in all areas and does not provide a good indication of long-term relative humidity trends.

Measurements should be taken within ductwork as well as in open spaces at varying heights to achieve greater accuracy. When the instrument is moved from one area to another with different ambient conditions, it needs to stabilize for a period of time before taking measurements. Humidity measurements performed in a duct require less time to stabilize due to the air velocity in the duct accelerating the stabilization process.

- High end thermo-anemometers with humidity sensor or thermo-hygrometers with data logging features can be used to monitor temperature or humidity conditions as they change over time. This data can then be downloaded for analysis.

CO₂ Measurements

CO₂ measurements are widely used to gauge the adequacy of the ventilation provided to an occupied space by an HVAC system. High CO₂ levels can be indicative of abnormal levels of VOCs which may affect occupant comfort and health, directly affecting productivity and operating costs. Diagnosing and identifying building ventilation problems can be done by comparing peak CO₂ readings between air handling zones or between rooms.

If the number of occupants in the space is consistent during the day, CO₂ levels will rise in the morning hours, fall during the lunch hour when people leave the area, and then rise again in the afternoon to a peak level. CO₂ measurements should be performed throughout the day to track trends or changes in ventilation. Measurements should be taken in different areas, in different air distribution zones, at varying heights and in both indoor and outdoor areas to ensure that the building is properly ventilated.

- High end IAQ monitors capable of datalogging CO₂ along with temperature and humidity throughout the day or week are important tools for IAQ investigations.
- High end IAQ monitors also are capable of computing the percentage of outside air based on supply, return, and outdoor air CO₂ levels.

Information on determining the percentage of outside air using CO₂ measurements can be found in *Appendix D*.



APPENDIXES

Appendix A—Performing a Duct Traverse

The following techniques can be used to measure air flow inside ducts using a velocity probe or pitot-static tube. When using a pitot-static tube, the individual velocities must be calculated for each pressure reading and averaged. Averaging pressure with a Pitot tube and then converting into velocity will give an incorrect result, especially if readings are more than ± 25 percent from the average pressure. For a pitot tube, velocity is proportional to the square root of pressure.

Where to Take the Measurement

In order to make air velocity measurements in a duct, it is best to measure at least 7.5 duct diameters downstream and at least 3 duct diameters upstream from any turns or flow obstructions. It is possible to do a traverse as little as 2 duct diameters downstream and 1 duct diameter upstream from obstructions, but measurement accuracy will be affected. When measuring rectangular ducts, use this formula to find the equivalent diameter of the duct when calculating the distance 7.5 diameters downstream and 3 diameters upstream:

$$\text{Equivalent Diameter} = \sqrt{\frac{4HV}{\pi}}$$

Where:

H = horizontal duct dimension

V = vertical duct dimension

$\pi = 3.14$

It is also possible to take a single reading to measure air velocity or air volume flow in a duct, measuring in the center of the duct and multiplying the reading by 0.9 to correct for the higher velocity at the center. If conditions are very good, an accuracy of ± 5 or 10 percent may be obtained this way. This method is not reliable, however, and should only be used where small duct size or other conditions do not permit a full traverse.

Traversing a Round Duct

Using the log-Tchebycheff method, the duct is divided into concentric circles, each containing equal area. An equal number of readings are taken from each circular area, thus obtaining the best average.

- Commonly, three concentric circles (6 measuring points per diameter) are used for ducts of 10 in. (25.4 cm) diameter and smaller.
- Four or five concentric circles (8 or 10 measuring points per diameter) are used for ducts larger than 10 in. (25.4 cm) diameter.

The preferred method is to drill 3 holes in the duct at 60° angles from each other as shown in the following figure. Three traverses are taken across the duct, averaging the velocities obtained at each measuring point. Then the average velocity is multiplied by the duct area to get the flow rate. (An alternative method uses 2 holes at 90° from each other, decreasing the number of traverses with the probe by one.)

Location of measuring points when traversing a round duct using log-Tchebycheff method

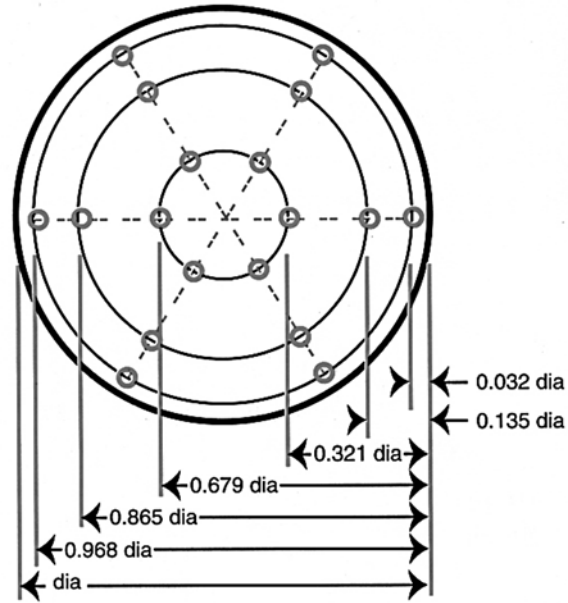

Round Duct size	#of Measuring Points Per Diameter	Position Relative to Inner Wall
<10 in. (76 cm)	6	0.032, 0.135, 0.321, 0.679, 0.865, 0.968
10 to 12 in. (76 to 91 cm)	8	0.021, 0.117, 0.184, 0.345, 0.655, 0.816, 0.883, 0.979
>12 in. (91 cm)	10	0.019, 0.077, 0.153, 0.217, 0.361, 0.639, 0.783, 0.847, 0.923, 0.981

Before taking the measurement, multiply the numbers in the table times the duct diameter to get insertion depth for the probe. (Do not forget to use the inside dimension of the duct if it is lined with insulation.)

Example: Using the three-hole, 60-degree method and six measuring points per diameter on an 8 in. (20.32 cm) diameter duct, the following results were obtained:

Insertion Depth	Hole # 1	Hole # 2	Hole # 3
.032 × 8 in. = .256 in. (.032 × 20.32 cm = .650 cm)	843 fpm (4.28 m/s)	857 fpm (4.35 m/s)	822 fpm (4.18 m/s)
.135 × 8 in. = 1.08 in. (.135 × 20.32 cm = 2.74 cm)	912 fpm (4.63 m/s)	929 fpm (4.72 m/s)	891 fpm (4.53 m/s)
.321 × 8 in. = 2.568 in. (.321 × 20.32 cm = 6.52 cm)	977 fpm (4.96 m/s)	993 fpm (5.04 m/s)	971 fpm (4.93 m/s)
.679 × 8 in. = 5.432 in. (.679 × 20.32 cm = 13.8 cm)	1003 fpm (5.1 m/s)	1031 fpm (5.24 m/s)	1018 fpm (5.17 m/s)
.865 × 8 in. = 6.92 in. (.865 × 20.32 cm = 17.6 cm)	922 fpm (4.68 m/s)	935 fpm (4.75 m/s)	912 fpm (4.63 m/s)
.968 × 8 in. = 7.744 in. (.968 × 20.32 cm = 19.7 cm)	869 fpm (4.41 m/s)	876 fpm (4.45 m/s)	861 fpm (4.37 m/s)

Total number of readings: 18
 Sum of all readings: 16,622 fpm (84.42 m/s)
 Average: 923 fpm—16,622/18 (4.69 m/s—84.42/18)

Traversing a Square Duct

Using the log-Tchebycheff method, the duct is divided into rectangular areas, which are further adjusted in size to account for effects of the duct wall on the airflow. A minimum of 25 points must be measured in order to get a good average. The number of data points to be taken along each side of the duct depends on how wide that side of the duct is.

- For duct sides less than 30 inches (76 cm), 5 traversal points must be taken along that side.
- For duct sides of 30 to 36 inches (76 to 91 cm), 6 points must be taken.
- For duct sides greater than 36 inches (91 cm), 7 points must be taken.

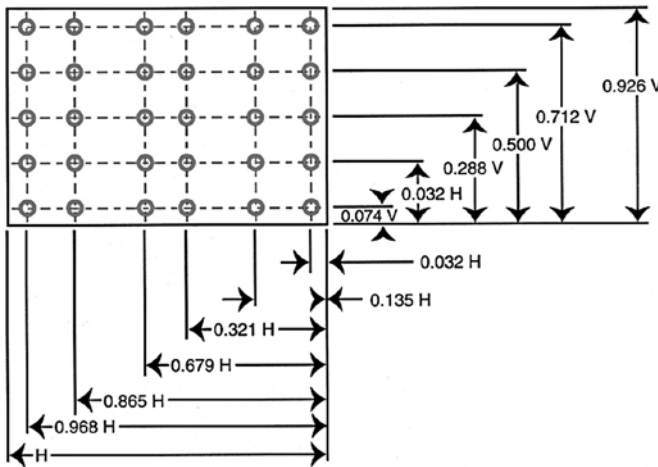

Location of measuring points for traversing a rectangular duct using log-Tchebycheff method

Multiply the numbers in the table times the duct dimension to get insertion depth for the probe. For this duct, a 30 to 36 in. (76 to 91 cm) horizontal dimension requires 6 points (or 6 traverse lines). A vertical dimension less than 30 in. (76 cm) requires 5 points (or 5 traverse lines).

Rectangular Duct size	# of Points or Traverse Lines per side	Position Relative to Inner Wall
<30 in. (76 cm)	5	0.074, 0.288, 0.500, 0.712, 0.926
30 to 36 in. (76 to 91 cm)	6	0.061, 0.235, 0.437, 0.563, 0.765, 0.939
>36 in. (91 cm)	7	0.053, 0.203, 0.366, 0.500, 0.634, 0.797, 0.947

Example: The following results were obtained on a 24 by 18 in. (61 by 46 cm) rectangular duct using the five point per side traverse method:

Insertion Depth	Hole # 1	Hole # 2	Hole # 3	Hole # 4	Hole # 5
.074 × 24 in. = 1.776 in. (.074 × 61 cm = 4.5 cm)	929 fpm (4.72 m/s)	903 fpm (4.59 m/s)	941 fpm (4.78 m/s)	911 fpm (4.63 m/s)	918 fpm (4.66 m/s)
.288 × 24 in. = 6.912 in. (.288 × 61 cm = 17.6 cm)	1048 fpm (5.32 m/s)	1064 fpm (5.41 m/s)	1103 fpm (5.60 m/s)	1027 fpm (5.22 m/s)	1033 fpm (5.25 m/s)
.500 × 24 in. = 12 in. (.500 × 61 cm = 30.5 cm)	1067 fpm (5.42 m/s)	1134 fpm (5.76 m/s)	1152 fpm (5.85 m/s)	1121 fpm (5.69 m/s)	1087 fpm (5.52 m/s)
.712 × 24 in. = 17.088 in. (.712 × 61 cm = 43.4 cm).	1104 fpm (5.61 m/s)	1179 fpm (5.99 m/s)	1209 fpm (6.14 m/s)	1182 fpm (6.00 m/s)	1127 fpm (5.73 m/s)
.926 × 24 in. = 22.224 in. (.926 × 61 cm = 56.5 cm).	891 (4.53 m/s)	969 (4.92 m/s)	981 (4.98 m/s)	977 (4.96 m/s)	944 (4.80 m/s)

Total number of readings: 25

Sum of all readings: 26,001 fpm 132.08 m/s

Average: 1040 fpm—26,001/25 5.28 m/s (132.08/25)

Appendix B—Capture Hood Flow Resistance

All capture hoods cause flow resistance on the air handling system. Just as different diffuser styles have their own characteristic flow resistance, so do capture hoods. This added resistance reduces the actual volume of air exiting the diffuser. In the majority of cases, this error is less than or equal to the accuracy of the instrument. Proportional balancing techniques will also assist in making these effects negligible.

To determine if flow resistance effects are important, perform duct traverses* to determine the volume rate exiting a diffuser both with and without the capture hood in place. The difference between the volume rate with and without the capture hood in place is the flow resistance effect for that diffuser.

To determine a correction factor for flow resistance that can be used on similar diffusers and duct configurations, use the volume rates as determined from the duct traverses when performed with and without the hood applied to the diffuser or grill as follows.

$$CF = V_{\text{no hood}} / V_{\text{hood}}$$

Where:

V_{hood} = Flow rate with the hood in place on the diffuser

$V_{\text{no hood}}$ = Flow rate without the hood in place on the diffuser

CF = Correction factor

$$V_{\text{corrected}} = CF \times V_{\text{measured}}$$

Where:

V_{measured} = Volume rate as displayed by the capture hood

$V_{\text{corrected}}$ = Volume rate corrected for the flow resistance of the capture hood

*Be sure to traverse the duct connected to the diffuser being tested. Also verify that there are no leaks in the duct between the traverse location and the diffuser or in the duct to diffuser connection.

Appendix C—Characterizing a Capture Hood to an Outlet Using a Correction Factor

Alnor Balometer® capture hoods are calibrated on a wind tunnel with a 2 × 2 ft (61 × 61 cm) diffuser for supply and exhaust. To minimize recirculation regions (non-laminar flows on one side of the hood), hood sizes should match the diffuser being measured as closely as possible.

Large recirculation regions will affect volume flow readings. Different diffuser sizes cannot be directly compared. On a 2 × 2 ft (61 × 61 cm) diffuser using a 2 × 2 ft (61 × 61 cm) hood, there are no recirculation regions. If the Balometer® hood is used on a small diffuser, the recirculation regions will create turbulence and the accuracy will be impaired. The following numbers are examples of what may happen. Do NOT use these numbers as correction factors.

Proper airflow with no recirculation regions

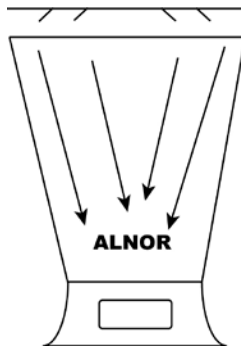

2 × 2 ft (61 × 61 cm) diffuser
True air flow = 100 ft³/min (170 m³/h)
Hood air flow = 100 ft³/min (170 m³/h)

Poor airflow with recirculation regions

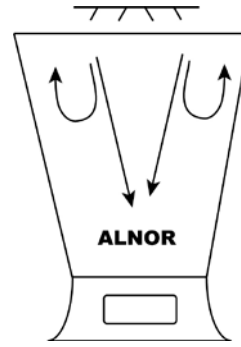

10 × 10 in. (25 × 25 cm) diffuser
True air flow = 100 ft³/min (170 m³/h)
Hood air flow = 90 ft³/min (153 m³/h)

In addition to getting an inaccurate measurement on a 10 × 10 in. (25 × 25 cm) outlet, positioning it differently may give different results.

Balometer® hood centered

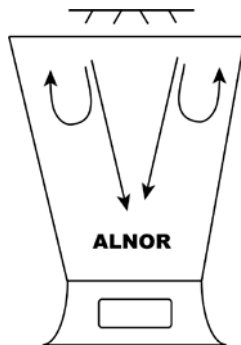

10 × 10 in. (25 × 25 cm) diffuser
True air flow = 100 ft³/min (170 m³/h)
Hood air flow = 90 ft³/min (153 m³/h)

Balometer® hood NOT centered

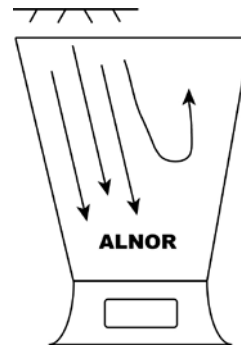

10 × 10 in. (25 × 25 cm) diffuser
True air flow = 100 ft³/min (170 m³/h)
Hood air flow = 80 ft³/min (136 m³/h)

Characterizing the hood to the outlet being measured is accomplished by performing a duct traverse of the branch leading to the outlet and comparing it to the hood reading. Divide the duct traverse reading by the hood reading to come up with a correction factor to be applied to the hood readout. This correction factor can then be used on similar outlet and duct configurations.

To determine a correction factor for the hood to match a duct traverse, use the following formula:

$$CF = Dtr / Hr$$

Where:

CF = Correction Factor
Dtr = Duct Traverse Reading
Hr = Hood Reading

To apply the correction factor to the hood readout, use the following formula:

$$Hc = Hr \times CF$$

Where:

Hc = Corrected Hood Reading
Hr = Hood Reading
CF = Correction Factor

Appendix D—Determining the Percentage of Outside Air Using Either Temperature or CO₂ Measurements

The introduction of fresh air helps dilute unwanted pollutants and get them out of the building faster. ASHRAE Standard 62 presents recommendations pertaining to ventilation, or the amount of fresh air introduced into a given area. The Standard recommends that indoor CO₂ concentrations not exceed 700 ppm (parts per million) above the outside value. It also recommends a minimum volume of outside air to be supplied to each person over time, depending on the type of space and activity being performed, expressed in cubic feet per minute per person.

The amount of outside air entering the building or an occupied space can be calculated as a percentage of the total air volume. Three measurements need to be taken: supply air, return air and outside air. The supply air must be measured before it enters the room and is diluted. This can be accomplished by placing the probe inside the supply register/diffuser. The return air can be measured at the face of the return grille or inside the return duct. If more than one return, measure at each and sum the results. This calculation can be done using either temperature or CO₂ measurements.

- Using temperature to determine the percentage of outside air is not an ideal method to use in mild climates when the inside and outside temperatures are too close to each other.
- CO₂ measurements should not be used if there are not enough occupants to generate sufficient CO₂.

The equation to determine the percentage of outdoor air is as follows:

$$\% \text{ outside air} = \frac{\text{return air measurement}^* - \text{supply air measurement}^*}{\text{return air measurement}^* - \text{outside air measurement}^*} \times 100$$

*measurement refers to either CO₂ or temperature

The percentage of outdoor air calculated in a ventilation assessment can be multiplied by the volume of air entering a space to determine the amount of fresh air, in cubic feet per minute.

$$\text{Air flow (cfm or m}^3\text{/h)} \times \frac{\%OA}{100} = \text{OA}\% \text{ cfm or m}^3\text{/h}$$

Divide this result by the number of occupants to determine the volume of outdoor air per person.

$$\frac{\text{OA}\% \text{ cfm}}{\# \text{ of people}} = \text{volume of OA per person (in cfm or m}^3\text{/h)}$$

This calculation can be compared to the table in ASHRAE Standard 62 to determine if an adequate amount of outside air per person is being supplied for a particular type of space. The following table lists a few examples taken from Table 2 in the Standard.

Application	cfm/person (outdoor air)
Auditoriums/theaters	10
Computer lab	10
Conference rooms	5
Courtrooms	5
Dining areas	7.5
Hotel rooms	5
Lecture hall	7.5
Libraries	5
Main entry lobbies	5
Museums	7.5
Office space	5
Residential living areas	5
Retail stores (typical)	7.5
School classroom	10
School laboratories	10

Dampers controlling the air intake can be adjusted to allow more or less outside air into the system in order to achieve these target levels.

Appendix E—Air Changes per Hour (ACH)

Air flow can also be used to determine the number of air changes that occur in a space over a period of one hour. This is accomplished by determining the supply cfm (cubic feet per hour) or cmh (cubic meters per hour) and dividing it by the total volume of a space (length \times width \times height) to come up with the number of air exchanges per hour. Likewise, the calculated fresh air percentage can be applied to this air changes calculation to determine changes of fresh air over time in a given space. The exchange of air between inside and outside is important in diluting and removing unwanted contaminants. These calculations are essential to properly maintain a comfortable, safe environment for building occupants, to help optimize the efficiency of the HVAC system, and to control operating costs.

Example:

Total supply air is 225 cfm (382 m³/h)

Total supply air in one hour = 13,500 cfm (225 cfm \times 60 min/hr), (382 m³/h)

Room dimensions are 16 \times 12 \times 8 ft = 1536 ft³ (4.88 \times 3.66 \times 2.44 m = 43.58 m³)

13,500 cfm / 1536 ft³ = 8.78 ACH (382 m³/h/43.58 m³ = 8.77 ACH)

Assume the outside air is 25% of the total volume.

8.78 ACH \times .25 = 2.2 ACH of outside air

**Appendix F—Thermal Comfort:
Temperature and Humidity**

Thermal comfort is a combination of temperature, humidity, air velocity, activity, clothing, and physiology. The main indicators of thermal comfort are temperature and humidity measurements. The recommended temperature range perceived as comfortable is 73 to 79°F (22.7 to 26.1°C) during the summer and 68 to 76°F (20 to 24.4°C) in the winter. Indoor humidity levels should be maintained between 30 to 60 percent for optimum comfort (ASHRAE Standard 55).

ASHRAE Standard 55 links temperature and humidity together to provide a measure of thermal comfort. The objective should be to set the appropriate temperature and humidity levels to maximize occupant comfort and to satisfy at least 80 percent of the occupants while controlling energy consumption. The "comfort zone" shown on the graph is based on the subjective response of people tested under a variety of conditions and their perception of what was or was not comfortable.

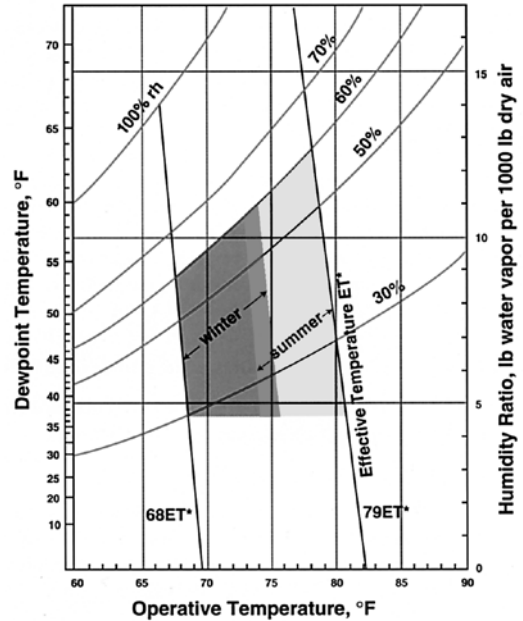

Appendix G—Density Correction

Velocity is generally expressed in one of two ways: actual (true) velocity or standard velocity. Actual velocity is the average speed at which the molecules are traveling. Standard velocity is referenced to standard conditions (using a reference of 70°F [21.1°C] and 29.92 in. Hg [101.4 kPa]) and is equal to the actual velocity of the air only when the air is at standard density. The Alnor calibration facilities adjust the actual velocity so that the same number of molecules per unit time are passing over the probe, as if the density were standard density. This makes the instruments display standard velocity.

As a practical matter, many users do not concern themselves with standard versus actual air velocity corrections unless the density of air in their application is more than 10 percent different from standard air density.

Density Correction for Thermo-Anemometers

Thermo-anemometer sensors measure mass air flow velocity which is a measurement of the air mass moving past the sensor and is displayed as standard velocity. Air mass is what gives air its heat holding capacity. Since thermal anemometers measure air mass and display it as standard velocity, many people doing measurements on indoor air are more concerned with standard air velocity.

Standard readings can be converted to actual air velocity to compensate for temperature and barometric pressures. Actual or standard measurements will give the same readings at standard conditions (using a reference of 70°F [21.1°C] and 29.92 in. Hg [101.4 kPa]), but not if pressure or temperature stray from standard conditions.

To calculate actual air velocity, multiply the standard velocity reading indicated by the thermo-anemometer by the following density correction factor:

$$\text{Actual Velocity} = (\text{Standard Velocity}) [(460 + T) / (460 + 70)] \times 29.92 / P_m$$

or

$$\text{Actual Velocity} = (\text{Standard Velocity}) [(273 + T_m) / (273 + 21.1)] \times 101.4 / P$$

Where:

- T = Ambient temperature in degrees Fahrenheit
- P_m = Ambient pressure in inches of Hg.
- T_m = Ambient temperature in degrees Centigrade
- P = Ambient pressure in kPa

Density Correction for Pressure Based Manometers or Deflecting Vane Anemometers

Manometers and deflecting vane anemometers read a nominal velocity that is neither standard nor actual, but a combination of both. This is the velocity read by any Pitot tube and pressure device that does not perform a density correction.

When Bernoulli's equation is applied to the Pitot-static probe, the resultant equation has the form $\text{fpm} = 4005 \sqrt{\Delta P (\text{in. H}_2\text{O})}$ ($\text{m/s} = 1.29 \sqrt{\Delta P (\text{Pa})}$) when the density of the air is 0.075 lb/ft³ (0.366 kgs/m³). The velocity values displayed by the pressure instrument are the actual velocities *only* if the density where the Pitot probe measurements are being taken is 0.075 lb/ft³ (0.366 kgs/m³). Otherwise, a correction step must be performed to obtain a correct value.

Nominal velocity is a velocity reading that is between actual and standard velocity. It is a good estimation of the actual or standard velocity. Nominal measurements are made using a pitot tube.

Actual velocity is the velocity at which a molecule would be traveling in the air stream.

Standard velocity is the velocity as if the measurement was taken with a thermal anemometer at standard temperature and barometric pressure.

Standard (or mass) velocity in imperial units may be calculated by applying the following formula.

$$V \text{ (standard)} = V \text{ (displayed)} \times [P\text{(actual)} / P\text{(standard)}]^{1/2}$$

Where:

V (displayed) = Velocity displayed by manometer

P (standard) = 29.92 in. Hg

P (actual) = Density of air where the pitot tube is located

Actual (or True) velocity may be calculated by applying the following formula.

$$V \text{ (actual)} = V \text{ (displayed)} \times [P\text{(standard)} / P\text{(actual)}]^{1/2}$$

Where:

V (displayed) = Velocity displayed by manometer

P (standard) = 29.92 in. Hg

P (actual) = Density of air where the pitot tube is located

Altitude versus Barometric Pressure

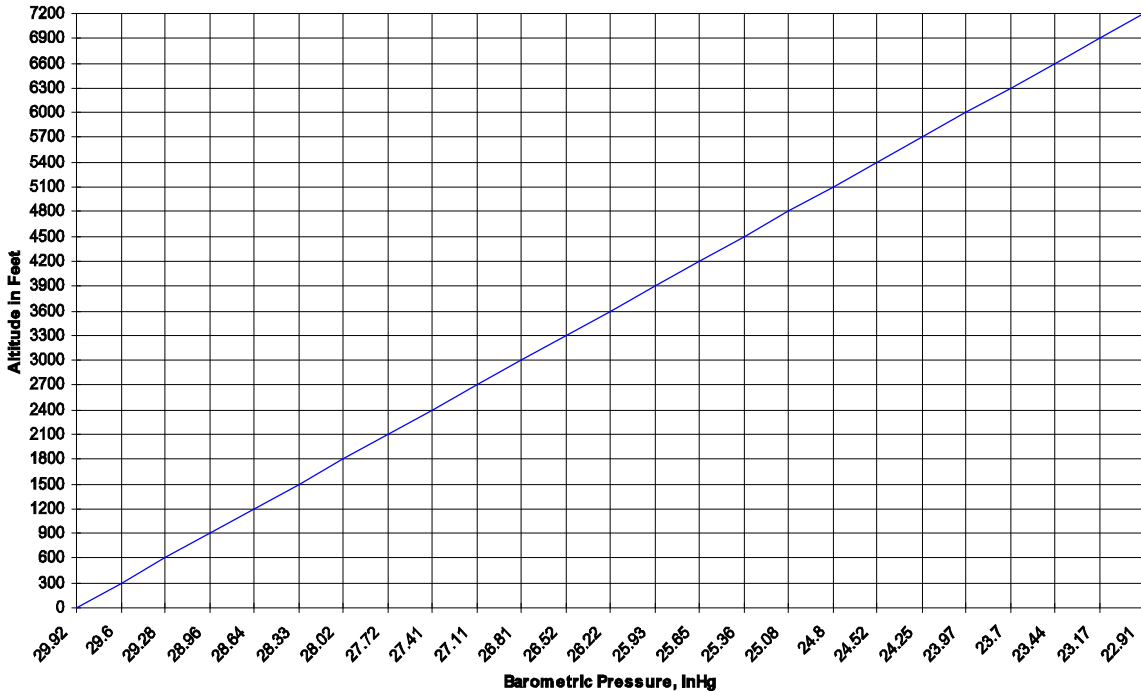

Note: This chart is intended to give the general indication of pressure at various altitudes when referenced to sea level. This chart does not take into consideration the day-to-day variations of barometric pressure.

In the United States, the barometric pressure reported by the National Weather Service is corrected to sea level and, therefore, cannot be used unless your measurements are taken at sea level. The preferred method is to use the atmospheric pressure at the location of the measurement.

Standard (or mass) velocity in metric units may be calculated by applying the following formula.

$$V (\text{standard}) = V (\text{displayed}) \times [P(\text{actual}) / P(\text{standard})]^{1/2}$$

Where:

- V (displayed) = Velocity displayed by manometer
- P (standard) = 101.4 kPa
- P (actual) = Density of air where the pitot tube is located

Actual (or True) velocity may be calculated by applying the following formula.

$$V (\text{actual}) = V (\text{displayed}) \times [P(\text{standard}) / P(\text{actual})]^{1/2}$$

Where:

- V (displayed) = Velocity displayed by manometer
- P (standard) = 101.4 kPa
- P (actual) = Density of air where the pitot tube is located

Altitude versus Barometric Chart

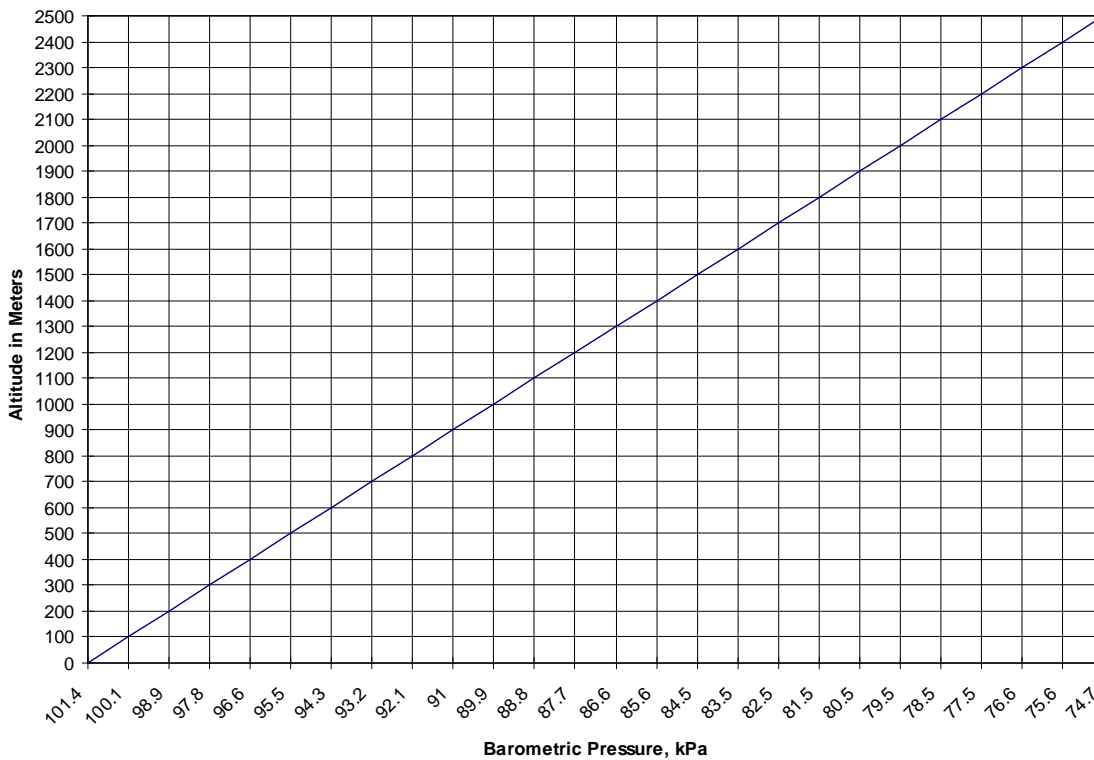

In the United States, the barometric pressure reported by the National Weather Service is corrected to sea level and, therefore, cannot be used unless your measurements are taken at sea level. The preferred method is to use the atmospheric pressure at the location of the measurement.

Appendix H—Useful Calculations

Total Pressure Formula

Where:

Basic formula: TP (Total Pressure) = VP + SP

Velocity unknown: SP (Static Pressure) = TP - VP

Area unknown: VP (Velocity Pressure) = TP - SP

Converting Velocity Pressure to fpm

For standard air density (.075 lb/ft³ or 1.20 kgs/m³), use formula:

$$\text{fpm} = 4005 \times \sqrt{VP} \qquad \text{m/s} = 1.29 \times \sqrt{VP}$$

For non-standard air density, use formula:

$$\text{fpm} = 1096 \times \sqrt{VP/\text{Density (in. Hg)}} \qquad \text{m/s} = 1.412 \times \sqrt{VP/\text{Density (kPa)}}$$

Where:

VP = in. H₂O or Pa

Air Flow Formulas

To find the volume of air flowing through ductwork, inlets, outlets, hoods, etc., use the following formula:

Basic formula: Q = AV

Velocity unknown: V = Q/A

Area unknown: A = Q/V

Where:

Q = volume flow rate in cfm (m³/h)

A = area in sq. ft. (m²)

V = velocity in fpm (m/s)

Area Formulas

To determine the area for a rectangular duct:

$$A = L \times W/144$$

$$A = L \times W$$

Where:

A = ft²

L = length in inches

W = width in inches

A = ft²

L = length in feet

W = width in feet

$$A = L \times W/10000$$

$$A = L \times W$$

Where:

A = m²

L = length in centimeters

W = width in centimeters

A = m²

L = length in meters

W = width in meters

To determine the area for round duct:

$$A = \pi r^2/144$$

$$A = \pi r^2/10000$$

A = ft²

π = 3.14

r = radius in inches

A = m²

π = 3.14

r = radius in centimeters

Example: The dimension of a rectangular duct is 24 × 36 in. (61 × 91.4 cm) The average air velocity is 1000 fpm (5.08 m/s). Using the formula for determining the area of a rectangular duct, you will obtain an area of 6 ft² (0.557 m²) Inputting the area into the volume flow formula along with the average velocity, you will obtain 6000 cfm (10196 m³/h).

$$A = L \times W/144$$

$$A = 24 \times 36 \text{ in.}/144$$

$$A = 6 \text{ ft}^2$$

or

$$A = L \times W/10000$$

$$A = 61 \times 91.4 \text{ cm}/10000$$

$$A = 0.55754 \text{ m}^2$$

$$Q = AV$$

$$Q = 6 \text{ ft}^2 \times 1000 \text{ fpm}$$

$$Q = 6000 \text{ cfm}$$

$$Q = AV$$

$$Q = 0.55754 \text{ m}^2 \times 5.08 \text{ m/s}$$

$$Q = 2.8323032 \text{ m}^3/\text{s} \times 60$$

$$Q = 169.93819 \text{ m}^3/\text{min} \times 60$$

$$Q = 10196 \text{ m}^3/\text{h}$$

Subtracting Obstructions From Area

If vanes or bars obstruct the area of air flow, the area of obstruction must be subtracted from the total area. If bars obstruct 0.5 ft² (0.0465 m²) of area in the 24 × 36 in. (61 × 91.4 cm) duct:

$$Q = AV$$

$$Q = (6 - 0.5) \text{ ft}^2 \times 1000 \text{ fpm}$$

$$Q = 5500 \text{ cfm}$$

$$Q = AV$$

$$Q = (0.557 - 0.0465) \text{ m}^2 \times 5.08 \text{ m/s} \times 60 \times 60$$

$$Q = 9336 \text{ m}^3/\text{h}$$

Hydronic Equations

$$Q = 500 \times \text{gpm} \times \Delta t$$

$$Q = 4.190 \times \text{l/s} \times \Delta t$$

Where:

Q = heat flow (Btu/hr)

gpm = gallons per minute

Δt = temperature difference (°F)

Q = heat flow in watts

l/s = liters per second

Δt = temperature different (°C)

$$\Delta P_2 / \Delta P_1 = (\text{gpm}_2 / \text{gpm}_1)^2$$

$$\text{m}^3/\text{h}_1)^2$$

$$\Delta P_2 / \Delta P_1 = (\text{l/s}_2 / \text{l/s}_1)^2 \text{ or } \Delta P_2 / \Delta P_1 = (\text{m}^3/\text{h}_2 /$$

Where:

ΔP = pressure difference (psi)

gpm = gallons per minute



















ΔP = pressure difference (kpu)

m³/h = cubic meters per hour

ΔP = pressure difference (kPa)

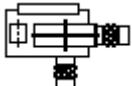
l/s = liters per second

Appendix I—Common HVAC Blueprint Symbols

<p>UNIT HEATER (PROPELLER)</p> 	<p>UNIT HEATER (CENTRIFICAL+)</p> 	<p>UNIT VENTILATOR</p> 	<p>THERMOMETER</p> 	<p>DIRECTION OF FLOW</p> 
<p>FLEXIBLE CONNECTION</p> 	<p>DUCTWORK WITH ACCOUSTICAL LINING</p> 	<p>FIRE DAMPER WITH ACCESS DOOR</p> 	<p>MANUAL VOLUME DAMPER</p> 	
<p>AUTOMATIC VOLUME DAMPER</p> 	<p>EXHAUST, RETURN OR OUTSIDE AIR DUCT - SECTION</p> 	<p>SUPPLY DUCT SECTION</p> 	<p>CEILING DIFFUSER SUPPLY OUTLET</p> 	<p>CEILING DIFFUSER SUPPLY OUTLET</p> 
<p>FAN AND MOTOR WITH BELT GUARD</p> 	<p>FLOOR REGISTER</p> 	<p>TURNING VANES</p> 	<p>LOUVER OPENING</p> 	<p>LINEAR DIFFUSER</p> 

Appendix J—Typical HVAC System Showing Some Measurement Locations

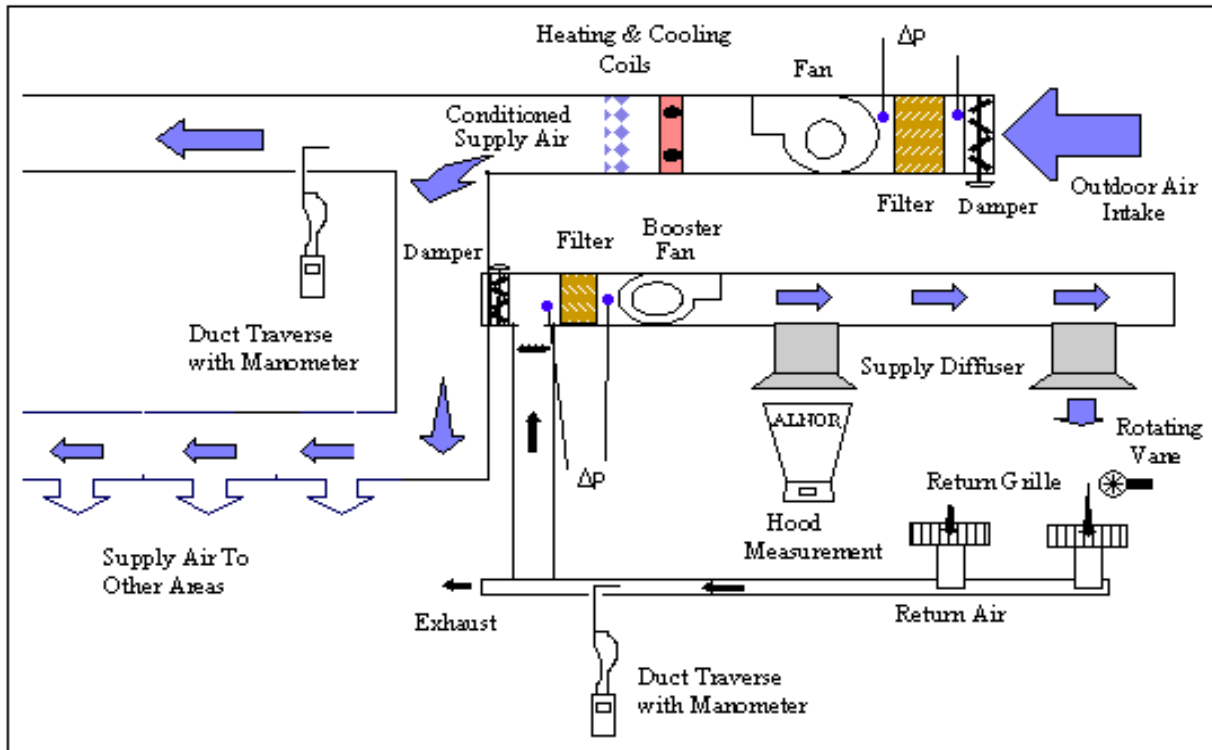

GLOSSARY

Absolute Pressure	Pressure above a perfect vacuum; the sum of atmospheric and gauge pressure.
Actual Velocity	The velocity at which a molecule would be traveling in the air stream.
Airflow	The movement of air.
Air Handling Unit (AHU)	Includes an air intake, fan (blower), filters, heating and cooling coils, and humidification/dehumidification equipment; conditions the air flow for distribution via ductwork.
Back Pressure	A static pressure increase due to constriction of air flow.
Balancing	Adjustment of the HVAC system to ensure operation in accordance with design.
cfh	cubic feet per hour
cfm	cubic feet per minute
cmh	cubic meters per hour
Constant Volume System	The volume of air delivered to an occupied zone by this system does not change, or changes very little. The discharge temperature is controlled in the zone by a temperature controller which activates heating and/or cooling coils.
Diffuser	A square, rectangular, or circular air distribution outlet designed to direct and distribute air in a desired pattern.
Duct Traverse	A method of determining average air velocity in a duct; average velocity can be multiplied by the duct area to calculate air volume or flow rate.
Face Velocity	Air velocity perpendicular to a fume hood or spray booth face.
fpm	feet per minute
Gauge Pressure	Pressure above atmospheric pressure.
gpm	gallons per minute
Heat Pumps	A type of refrigeration system that draws out heated indoor air in the summer to keep an occupied space cool and removes heat from the cool outdoor air and transfers it to the inside during the winter months.
l/s	liters per second
m/s	meters per second
m³/h	cubic meters per hour
Manometer	An instrument used to measure air pressure.
Multi-zone System	Delivers conditioned air to several zones from a single, central air handling unit. The zones served should have similar thermal load requirements such as offices or classrooms. Conditions in each space are maintained by temperature controllers in each zone which vary the amount of heated or cooled air delivered.
Nominal Velocity	A velocity reading that is between actual and standard velocity. It is a good estimation of the actual or standard velocity. Nominal measurements are made using a pitot tube.

Pitot Tube	A small bent tube which measures velocity pressure by means of the differential pressure between total and static pressure.
Return	The half of an HVAC system which exhausts air from various areas of a building back to some type of air handler or out of a building.
Rotating Vane Anemometer	An instrument for measuring air velocity related to revolutions over time.
RTD	resistive temperature detector
Single-zone System	Serves a single, temperature controlled zone. Typically found in small shops or computer rooms where the environment and usage generally remains the same.
Standard Velocity	The velocity measured with a thermal anemometer at standard temperature and barometric pressure.
Static Pressure	Pressure exerted by a fluid; total pressure minus velocity pressure.
Supply	The half of an HVAC system which delivers air from some type of air handler to various areas of a building.
Thermal Anemometry	A means of detecting air velocity related to the heat loss of a heated wire or film.
Thermocouple Effect	Voltage developed by joining two dissimilar metals to measure temperature differential.
Thermometer	A device used to measure temperature.
Unit Ventilator	Single, self-contained system typically found in hotel/motel rooms, schools, garages, and other applications requiring individual room environments to be separately maintained.
VAV (Variable Air Volume) System	Air volume to a zone is adjusted via a damper that responds to a zone thermostat controlling heating and cooling coils. VAV boxes can be found on multi-zone system duct runs that are new to the building or are considerably far away from the central air handler unit.
Velocity Pressure	Positive pressure caused by moving air; related to air speed squared; total pressure minus static pressure.

REFERENCES

The following is a partial list of organizations offering information on ventilation:

Air Conditioning Contractors of America (ACCA) – www.acca.org
Air Conditioning and Refrigeration Institute (ARI) – www.lightindustries.com/ARI/
Air Diffusion Council (ADC) – www.flexibleduct.org
American Board of Industrial Hygienists (ABIH)— www.abih.org
American Indoor Air Quality Council (AmIAQ)—www.iaqcouncil.org
American National Standards Institute (ANSI) – www.ansi.org
American Society of Heating, Refrigeration and Air Conditioning Engineers (ASHRAE) –
www.ashrae.org
ASHRAE Fundamentals Handbook—www.ashrae.org
ASHRAE Standard 55, Thermal Environmental Conditions for Human Occupancy
ASHRAE Standard 62, Ventilation for Acceptable Air Quality
ASHRAE Standard 111, Practices for Measuring, Testing, Adjusting, and Balancing of Building
Heating, Ventilation, Air-Conditioning, and Refrigeration Systems
American Society of Safety Engineers (ASSE) – www.asse.org
Building Owners and Managers Association (BOMA)—www.boma.org
Healthy Buildings International (HBI) – www.hbi.com.au
Indoor Air Quality Association (IAQA) – www.iaqa.org
National Air Filtration Association (NAFA) – www.nafahq.org
National Institute for Occupational Safety and Health (NIOSH) –
www.cdc.gov/niosh/homepage.html
National Institute of Health (NIH) – www.nih.gov
National Safety Council (NSC)—www.nsc.org
The Association of Energy Engineers—www.aee.com
Guide to Energy Management, 2nd edition
Energy Management Handbook, 3rd edition
U.S. Department of Health and Human Services (HHS) – www.hhs.gov
U.S. Department of Labor Occupational Health and Safety Administration (OSHA) – www.osha.gov
National Environmental Balancing Bureau (NEBB)—www.nebb.org
Associated Air Balance Council (AABC)—www.aabchq.com
Sheet Metal and Air Conditioning Contractors National Association (SMACNA)—www.smacna.org
U.S. Environmental Protection Agency (EPA) – www.epa.gov
U.S. Public Health Service (PHS)— <http://www.usphs.gov/>

A host of trade publications, books and web sites dedicated to ventilation issues also are excellent sources of information but are far too numerous to mention here.



Alnor Products, TSI Incorporated

Visit our website at www.alnor.com for more information.

USA **Tel:** +1 800 874 2811 **China** **Tel:** +86 10 8219 7688
India **Tel:** +91 80 67877200 **Singapore** **Tel:** +65 6595 6388