



QUICK START GUIDE



INSTALLING THE NETRONIX™ THIAMIS™ GSM/GPS COMMUNICATION MODEM IN THE ENVIRONMENTAL ENCLOSURE MODEL 854030

This guide will help you quickly install the Netronix™ Thiamis™ GSM/GPS Communication Modem in the Environmental Enclosure Model 854030.

Unpacking Netronix Thiamis GSM/GPS Communication Modem (801905)

1. Unpack Netronix Thiamis GSM/GPS Communication Modem (801905) and verify that all items listed in the following table are present.
2. Contact [TSI](#) immediately if items are missing or broken.

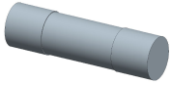
Qty.	Item Description	Reference Picture
1	Netronix Thiamis GSM/GPS Communication Modem	
1	GSM/GPS Antenna With Slip Nut	
1	RS232 to USB Converter Cable	

Qty.	Item Description	Reference Picture
1	Power Cable	
1	Spare Fuse	
2	6-32 Pan Head Screw	

Tools Needed for Installation

- Phillips Screw Driver

Installing Netronix Thiamis GSM/GPS Communication Modem (801905)

1. Remove slip nut from GSM/GPS antenna.

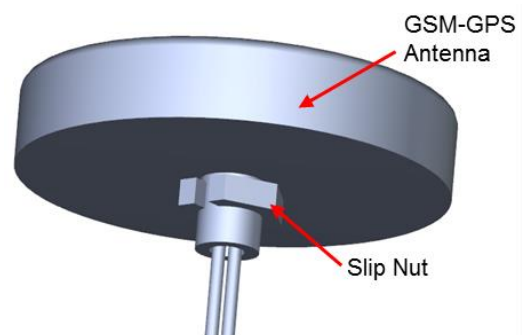

2. Attach GSM/GPS antenna as shown. **If you purchased a solar shield skip to step 3.**



3. Run GSM/GPS antenna cables through the antenna post and screw the antenna to the antenna post.
4. Attach the antenna post and antenna to the enclosure as shown, if you purchased a solar shield.

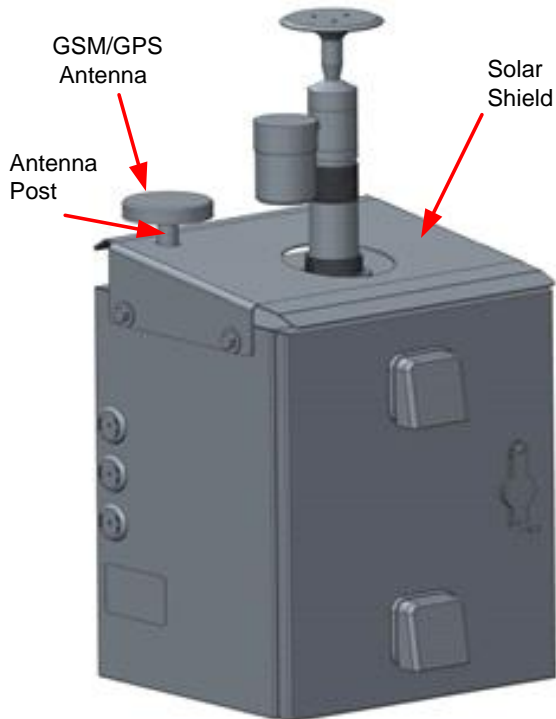

5. Tighten slip nut to secure GSM/GPS antenna to enclosure.
6. If you purchased a solar shield, tighten retaining nut (not shown) to secure the antenna post and GSM/GPS antenna to the enclosure (GSM/GPS cables not shown for clarity).
7. Install the Environmental DustTrak photometer into the Environmental Enclosure as shown in 854030 Enclosure manual.

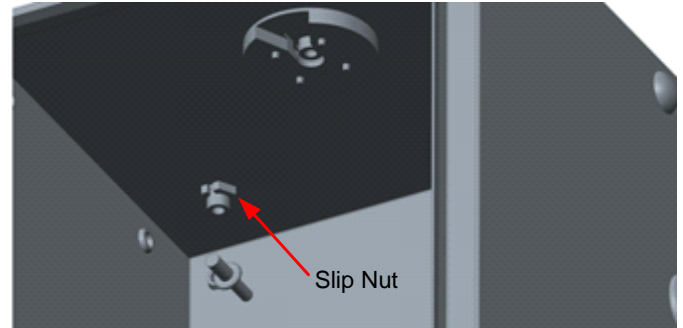

8. Detach the mounting plate from the Thiamis 1000 node.
9. Attach mounting plate to DustTrak monitor using a screw driver and the pan head screws.
10. Finally, re-attach the Thiamis node to the mounting plate.

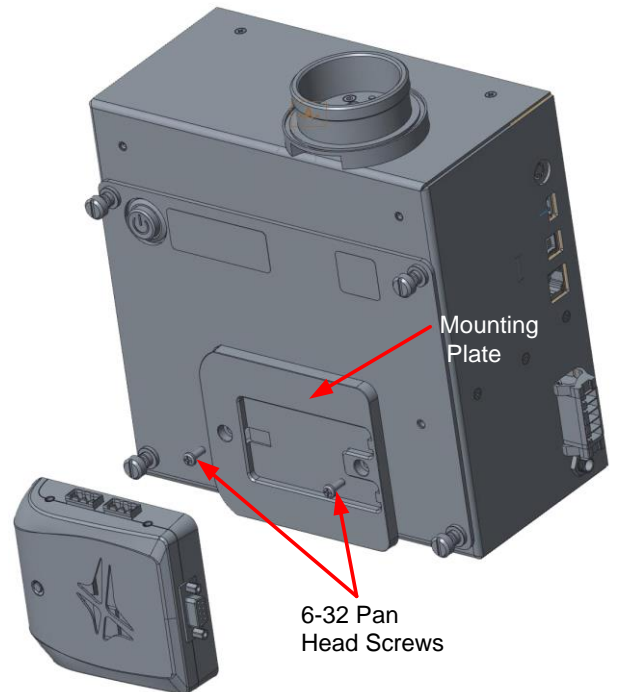

11. Connect the power cable, the RS232 to USB converter cable, the GSM cable, and the GPS cable to the Thiamis unit as shown.

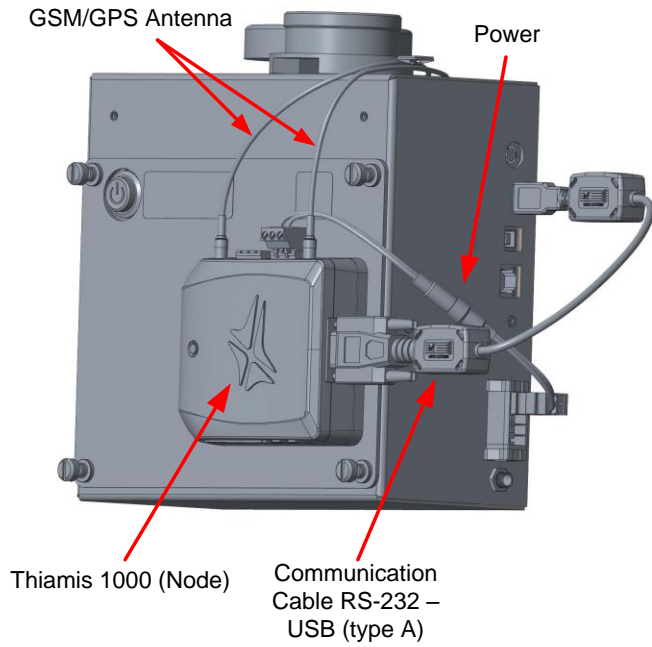



UNDERSTANDING, ACCELERATED

TSI Incorporated – Visit our website www.tsi.com for more information.

USA	Tel: +1 800 874 2811	India	Tel: +91 80 67877200
UK	Tel: +44 149 4 459200	China	Tel: +86 10 8219 7688
France	Tel: +33 1 41 19 21 99	Singapore	Tel: +65 6595 6388
Germany	Tel: +49 241 523030		